



**Model EX600B13**

**UHT-12™, high temperature, charge mode accelerometer kit containing a side exit accelerometer with shear sensing crystal, 10 ft integral hard-line cable, and integral charge amplifier**

**Installation and Operating Manual**

**For assistance with the operation of this product,  
contact the PCB Piezotronics, Inc.**

**Toll-free: 800-959-4464  
24-hour SensorLine: 716-684-0001  
Fax: 716-684-3823  
E-mail: [imi@pcb.com](mailto:imi@pcb.com)  
Web: [www.imi-sensors.com](http://www.imi-sensors.com)**



## Repair and Maintenance

PCB guarantees Total Customer Satisfaction through its “Lifetime Warranty Plus” on all Platinum Stock Products sold by PCB and through its limited warranties on all other PCB Stock, Standard and Special products. Due to the sophisticated nature of our sensors and associated instrumentation, **field servicing and repair is not recommended and, if attempted, will void the factory warranty.**

Beyond routine calibration and battery replacements where applicable, our products require no user maintenance. Clean electrical connectors, housings, and mounting surfaces with solutions and techniques that will not harm the material of construction. Observe caution when using liquids near devices that are not hermetically sealed. Such devices should only be wiped with a dampened cloth—never saturated or submerged.

In the event that equipment becomes damaged or ceases to operate, our Application Engineers are here to support your troubleshooting efforts 24 hours a day, 7 days a week. Call or email with model and serial number as well as a brief description of the problem.

## Calibration

Routine calibration of sensors and associated instrumentation is necessary to maintain measurement accuracy. We recommend calibrating on an annual basis, after exposure to any extreme environmental influence, or prior to any critical test.

PCB Piezotronics is an ISO-9001 certified company whose calibration services are accredited by A2LA to ISO/IEC 17025, with full traceability to SI through N.I.S.T. In addition to our standard calibration services, we also offer specialized tests, including: sensitivity at elevated or cryogenic temperatures, phase response, extended high or low frequency response, extended range, leak testing, hydrostatic pressure testing, and others. For more information, contact your local PCB Piezotronics distributor, sales representative, or factory customer service representative.

## Returning Equipment

If factory repair is required, our representatives will provide you with a Return Material Authorization (RMA) number, which we use to reference any information you have already provided and expedite the repair process. This number should be clearly marked on the outside of all returned package(s) and on any packing list(s) accompanying the shipment.

## Contact Information

PCB Piezotronics, Inc.  
3425 Walden Ave.  
Depew, NY14043 USA  
Toll-free: (800) 828-8840  
24-hour SensorLine: (716) 684-0001  
General inquiries: [info@pcb.com](mailto:info@pcb.com)  
Repair inquiries: [rma@pcb.com](mailto:rma@pcb.com)

For a complete list of distributors, global offices and sales representatives, visit our website, [www.pcb.com](http://www.pcb.com).

## Safety Considerations

This product is intended for use by qualified personnel who recognize shock hazards and are familiar with the precautions required to avoid injury. While our equipment is designed with user safety in mind, the protection provided by the equipment may be impaired if equipment is used in a manner not specified by this manual.

Discontinue use and contact our 24-Hour Sensorline if:

- Assistance is needed to safely operate equipment
- Damage is visible or suspected
- Equipment fails or malfunctions

For complete equipment ratings, refer to the enclosed specification sheet for your product.

## Definition of Terms and Symbols

The following symbols may be used in this manual:



### DANGER

Indicates an immediate hazardous situation, which, if not avoided, may result in death or serious injury.

**CAUTION**

Refers to hazards that could damage the instrument.

**NOTE**

Indicates tips, recommendations and important information. The notes simplify processes and contain additional information on particular operating steps.

**The following symbols may be found on the equipment described in this manual:**



This symbol on the unit indicates that high voltage may be present. Use standard safety precautions to avoid personal contact with this voltage.



This symbol on the unit indicates that the user should refer to the operating instructions located in the manual.



This symbol indicates safety, earth ground.



PCB工业监视和测量设备 - 中国RoHS2公布表

PCB Industrial Monitoring and Measuring Equipment - China RoHS 2 Disclosure Table

| 部件名称   | 有害物质   |        |        |              |            |              |
|--|--------|--------|--------|--------------|------------|--------------|
|  | 铅 (Pb) | 汞 (Hg) | 镉 (Cd) | 六价铬 (Cr(VI)) | 多溴联苯 (PBB) | 多溴二苯醚 (PBDE) |
| 住房   | 0      | 0      | 0      | 0            | 0          | 0            |
| PCB板   | X      | 0      | 0      | 0            | 0          | 0            |
| 电气连接器  | 0      | 0      | 0      | 0            | 0          | 0            |
| 压电晶体   | X      | 0      | 0      | 0            | 0          | 0            |
| 环氧   | 0      | 0      | 0      | 0            | 0          | 0            |
| 铁氟龙  | 0      | 0      | 0      | 0            | 0          | 0            |
| 电子   | 0      | 0      | 0      | 0            | 0          | 0            |
| 厚膜基板   | 0      | 0      | X      | 0            | 0          | 0            |
| 电线   | 0      | 0      | 0      | 0            | 0          | 0            |
| 电缆   | X      | 0      | 0      | 0            | 0          | 0            |
| 塑料   | 0      | 0      | 0      | 0            | 0          | 0            |
| 焊接   | X      | 0      | 0      | 0            | 0          | 0            |
| 铜合金/黄铜   | X      | 0      | 0      | 0            | 0          | 0            |
| 本表格依据 SJ/T 11364 的规定编制。                          |        |        |        |              |            |              |
| 0：表示该有害物质在该部件所有均质材料中的含量均在 GB/T 26572 规定的限量要求以下。  |        |        |        |              |            |              |
| X：表示该有害物质至少在该部件的某一均质材料中的含量超出 GB/T 26572 规定的限量要求。 |        |        |        |              |            |              |
| 铅是欧洲RoHS指令2011/65/ EU附件三和附件四目前由于允许的豁免。           |        |        |        |              |            |              |

CHINA RoHS COMPLIANCE

| Component Name         | Hazardous Substances |              |              |                                |                                |                                       |
|------------------------|----------------------|--------------|--------------|--------------------------------|--------------------------------|---------------------------------------|
|                        | Lead (Pb)            | Mercury (Hg) | Cadmium (Cd) | Chromium VI Compounds (Cr(VI)) | Polybrominated Biphenyls (PBB) | Polybrominated Diphenyl Ethers (PBDE) |
| Housing                | O                    | O            | O            | O                              | O                              | O                                     |
| PCB Board              | X                    | O            | O            | O                              | O                              | O                                     |
| Electrical Connectors  | O                    | O            | O            | O                              | O                              | O                                     |
| Piezoelectric Crystals | X                    | O            | O            | O                              | O                              | O                                     |
| Epoxy                  | O                    | O            | O            | O                              | O                              | O                                     |
| Teflon                 | O                    | O            | O            | O                              | O                              | O                                     |
| Electronics            | O                    | O            | O            | O                              | O                              | O                                     |
| Thick Film Substrate   | O                    | O            | X            | O                              | O                              | O                                     |
| Wires                  | O                    | O            | O            | O                              | O                              | O                                     |
| Cables                 | X                    | O            | O            | O                              | O                              | O                                     |
| Plastic                | O                    | O            | O            | O                              | O                              | O                                     |
| Solder                 | X                    | O            | O            | O                              | O                              | O                                     |
| Copper Alloy/Brass     | X                    | O            | O            | O                              | O                              | O                                     |

This table is prepared in accordance with the provisions of SJ/T 11364.

O: Indicates that said hazardous substance contained in all of the homogeneous materials for this part is below the limit requirement of GB/T 26572.

X: Indicates that said hazardous substance contained in at least one of the homogeneous materials for this part is above the limit requirement of GB/T 26572.

Lead is present due to allowed exemption in Annex III or Annex IV of the European RoHS Directive 2011/65/EU.



**INDUSTRIAL MONITORING INSTRUMENTATION DIVISION**

## **Piezoelectric ICP® Accelerometers Operating Guide**

### **Operating Guide with Enclosed Warranty Information**

**3424 Walden Avenue, Depew, New York 14043-2495**

**Phone (716) 684-0003**

**Fax (716) 684-3823**

**Toll Free Line 1-800-959-4IMI**

**MANUAL NUMBER: 18405  
MANUAL REVISION: A**

**ECN NUMBER: 49766**

**General**  
**OPERATING GUIDE**

for use with

**PIEZOELECTRIC ICP® ACCELEROMETERS**

SPECIFICATION SHEET, INSTALLATION DRAWING AND CALIBRATION INFORMATION ENCLOSED

IMI ASSUMES NO RESPONSIBILITY FOR DAMAGE CAUSED TO THIS PRODUCT AS A RESULT OF PROCEDURES THAT ARE INCONSISTENT WITH THIS OPERATING GUIDE

**1.0 INTRODUCTION**

Congratulations on the purchase of a quality ICP® industrial sensor. In order to ensure the highest level of performance for this product, it is imperative that you properly familiarize yourself with the correct mounting and installation techniques before attempting to operate this device. If, after reading this manual, you have any additional questions concerning this sensor or its application, feel free to call an Application Engineer at **716-684-0003** or **800-959-4464**.

Proper sensor selection requires special attention to three main areas: sensor design, dynamic expectations, and application environment.

Sensor design encompasses the actual sensing element, the physical material, and component selection for the sensor. Preferred industrial accelerometers employ a shear sensing element with either a quartz or ceramic crystal.

Quartz sensing elements are typically used when long-term stability and minimum output shifts due to temperature changes are desired. Ceramic sensing elements provide excellent resolution and durability in noisy environments, and can be designed to supply low-frequency and high-frequency measurements. Shear-design sensors are preferred because of their inherent insensitivity to adverse environmental influences, such as case or base strain and thermal transients. Internal case isolation and shielding is important in avoiding erroneous signals resulting from ground loops and pick-up of electromagnetic and radio frequency interference. Other critical material selection criteria include non-magnetic stainless steel housing, hermetic sealing, and industrial military connectors. See Figure 1.



**Figure 1.** Typical Industrial Shear Mode Accelerometer

Dynamic expectations are application-specific and refer to the frequency range of measurement and the anticipated amplitudes of vibration. After careful review of the machinery to be monitored, minimum and maximum measurement frequency ranges may be established. The minimum measurement frequency is normally related to any sub-harmonics of running speed or any lower frequencies where vibration data is to be collected. The maximum measurement frequency of interest is determined by the maximum number of harmonics of an event like running speed, bearing frequencies, or gear mesh. This measurement frequency range should be well within the specified frequency range of the sensor.

Amplitude range refers to the anticipated levels of vibration to be measured. These values are related to the alarm levels set for the machine. By carefully evaluating the idiosyncrasies of the machinery, the predictive maintenance engineer can estimate the minimum expected vibration levels and ensure that the electrical noise floor of the accelerometer is less than those levels.

The environment of the application is a critical consideration during program implementation. The sensor chosen must be capable of surviving the wide range of conditions to which it is subjected; therefore, take time to evaluate potential conditions, such as high temperatures and chemical contaminants. The specified temperature range of the sensor must conform to the fluctuations of the environmental temperature. If harsh industrial chemicals are present, the sensor requires hermetic sealing and construction that resists corrosion. Finally, specific location of the sensor within the environment must be sensible, as both cable and sensor may be damaged by imprudent installation in heavily traveled, physically punishing areas.

### 2.0 ICP® ACCELEROMETERS

Enclosed in the back of this guide is a Specification Sheet, which lists the complete performance characteristics of the particular sensor.

All ICP® sensors require a constant current power source for proper operation. A typical sensing system includes an ICP® sensor, ordinary two conductor cable and a basic constant current power supply (as shown in Figure 2).



Figure 2. Typical Sensor System

The signal conditioner consists of a well-regulated 18 to 30 VDC source (battery or line-powered), a current-regulating diode (or equivalent constant current circuit), and a capacitor for decoupling (removing the bias voltage) the signal.

The current-regulating device is used in place of a resistor for several reasons. The very high dynamic resistance of the diode yields a source follower gain which is extremely close to unity and independent of

input voltage. Also, the diode can be changed to supply higher currents for driving long cable lengths. Constant current diodes, as shown in Figure 3, should be used in ICP® signal conditioners. **(The correct orientation of the diode within the circuit is critical for proper operation.)** Except for special models, standard ICP® sensors require a minimum of 2 mA for proper operation.



Figure 3. Constant Current Diode

The typical limits for this type of diode are to a 4 mA maximum rating; however, several diodes can be placed in parallel for higher current levels. All line-powered signal conditioners should use higher capacity (up to 20 mA) constant current circuits in place of the diodes, particularly when driving long signal cables (see Section 5).

Decoupling of the data signal occurs at the output stage of the signal conditioner. A 10 to 30 µF capacitor coupled with a resistor shifts the signal level to essentially eliminate the sensor bias voltage. The result is a drift-free AC mode of operation.

### 3.0 OPTIONAL FEATURES

In addition to standard features, a variety of options are also available. When listed before the model number, the following prefix letters indicate that the sensor is manufactured or supplied with optional features:

- CS - Canadian Standards Association Approved Sensor
- D - Dummy, non-working sensor for display purposes
- EX - Cenelec Approved Sensor
- FM - Factory Mutual Approval Sensor
- HT - High temperature accelerometer (325 °F)
- LB - Low Bias electronics
- LC - Limited Calibration (one point calibration)
- LP - Low Pass filter
- M - Metric mounting hardware and cable length
- U - Usable demonstration sensor (does not meet one or more minor specifications)
- VO - Velocity Output Sensors



MS – Mine Safety Approved Sensors  
 TO – Temperature Output Sensor

**Note:** *Not all sensors are available with the optional prefixes. Contact the factory to discuss special features that may be needed.*

**4.0 INSTALLATION OVERVIEW**

When choosing a mounting method, consider closely both the advantages and disadvantages of each technique. Characteristics like location, ruggedness, amplitude range, accessibility, temperature, and portability are extremely critical. However, the most important and often overlooked consideration is the effect the mounting technique has on the high-frequency operating range of the accelerometer.

Shown in Figure 4 are six possible mounting techniques and their effects on the performance of a typical piezoelectric accelerometer. (**Note:** *Not all of the mounting methods may apply to your particular sensor.*) The mounting configurations and corresponding graph demonstrate how the high-frequency response of the accelerometer may be compromised as mass is added to the system and/or the mounting stiffness is reduced.

**Note:** *The low-frequency response is unaffected by the mounting technique. This roll-off behavior is typically fixed by the sensor's built-in electronics. However, when operating AC-coupled signal conditioners with readout devices having an input impedance of less than one megaohm, the low frequency range may be affected.*



**Figure 4.** Assorted Mounting Configurations and Their Effects on High Frequency

**4.1 STANDARD STUD MOUNT**

This mounting technique requires smooth, flat contact surfaces for proper operation and is recommended for permanent and/or secure installations. Stud mounting is also recommended when testing at high frequencies.

**Note:** *Do NOT attempt mounting on curved, rough, or uneven surfaces, as the potential for misalignment and limited contact surface may significantly reduce the sensor's upper operating frequency range.*



|                | 1/4-28 Stud | 1/4-28 Captive Screw |
|----------------|-------------|----------------------|
| A (in.)        | .250        | .250                 |
| B (in.)        | .350        | .350                 |
| Torque (ft-lb) | 2 to 5      | 2 to 5               |

**Figure 5.** Mounting Surface Preparation

**STEP 1:** First, prepare a smooth, flat mounting surface and then drill and tap a mounting hole in the center of this area as shown in Figure 5.

A precision-machined mounting surface with a minimum finish of 63 μin (0.0016 mm) is recommended. (If it is not possible to properly prepare the machine surface, consider using an adhesive mounting pad as a possible alternative.) Inspect the area, checking that there are no burrs or other foreign particles interfering with the contact surface.

**STEP 2:** Wipe clean the mounting surface and spread on a light film of grease, oil, or similar coupling fluid prior to installation. See Figure 6.



**Figure 6.** Mounting Surface Lubrication

Adding a coupling fluid improves vibration transmissibility by filling small voids in the mounting surface and increasing the mounting stiffness. For

semi-permanent mounting, substitute epoxy or another type of adhesive.

**STEP 3:** Hand-tighten the sensor/mounting stud to the machine, then secure the sensor with a torque wrench to the mounting surface by applying the recommended mounting torque. (See enclosed specification data sheet for proper mounting torque.)

It is important to use a torque wrench during this step. Under-torqueing the sensor may not adequately couple the device; over-torqueing may result in stud failure and possibly permanent damage.

**4.2 ADHESIVE MOUNT**

Adhesive mounting is often used for temporary installation or when the machine surface cannot be adequately prepared for stud mounting. Adhesives like hot glue or wax work well for temporary mounts; two-part epoxies and quick-bonding gels provide a more permanent mount.

**Note:** *Adhesively-mounted sensors often exhibit a reduction in high-frequency range. Generally, smooth surfaces and stiff adhesives provide the best frequency response. Contact the factory for recommended epoxies.*

**METHOD 1 – Adhesive mounting base**

This method involves attaching a base to the machine surface, then securing the sensor to the base. This allows for easy removal of the accelerometer.

**STEP 1:** Prepare a smooth, flat mounting surface. A minimum surface finish of 63 μin (0.0016 mm) generally works best.

**STEP 2:** Stud-mount the sensor to the appropriate adhesive mounting base according to the guidelines set forth in **STEPS 2** and **3** of the Stud Mount Procedure.

**STEP 3:** Place a small portion of adhesive on the underside of the mounting base. Firmly press down on the assembly to displace any extra adhesive remaining under the base. See Figure 7.



**Figure 7. Mounting Base: Adhesive Installation**

**METHOD 2 – Direct Adhesive Mount**

For restrictions of space or for convenience, most sensors (with the exception of integral stud models) can be adhesive-mounted directly to the machine surface.

**STEP 1:** Prepare a smooth, flat mounting surface. A minimum surface finish of 63 μin (0.0016 mm) generally works best.

**STEP 2:** Place a small portion of adhesive on the underside of the sensor. Firmly press down on the top of the assembly to displace any adhesive. Be aware that excessive amounts of adhesive can make sensor removal difficult. See Figure 8.



**Figure 8. Direct Adhesive Mounting**

**4.3 MAGNETIC MOUNT**

Magnetic mounting provides a convenient means for making portable measurements and is commonly used for machinery monitoring and other portable or trending applications.

**Note:** *The correct magnet choice and an adequately prepared mounting surface are critical for obtaining reliable measurements, especially at high frequencies. Poor installations can cause as much as a 50% drop in the sensor frequency range.*

Not every magnet is suitable for all applications. For example, rare earth magnets are commonly used because of their high strength. Flat magnets work well on smooth, flat surfaces, while dual-rail magnets are required for curved surfaces. In the case of non-magnetic or rough surfaces, it is recommended that the user first weld, epoxy, or otherwise adhere a steel mounting pad to the test surface. This provides a smooth and repeatable location for mounting.

**STEP 1:** After choosing the correct magnet type, inspect the unit, verifying that the mounting surfaces are flat and smooth. See Figure 9.

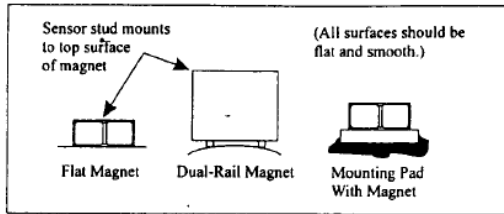

Figure 9. Magnet Types

**STEP 2:** Stud-mount the accelerometer to the appropriate magnet according to the guidelines set forth in **STEPS 2** and **3** of the Stud Mount Procedure.

**STEP 3:** Prepare a smooth, flat mounting surface. A minimum surface finish of 63  $\mu\text{in}$  (0.0016 mm) generally works best. After cleaning the surface and checking for burrs, wipe on a light film of silicone grease, machine oil, or similar-type coupling fluid.

**STEP 4:** Mount the magnet/sensor assembly to the prepared test surface by gently “rocking” or “sliding” it into place. See Figure 10.



Figure 10. Magnet Mounting

**Note:** *Magnetically mounting accelerometers carelessly has the potential to generate very high (and very damaging) g levels. To prevent damage, install the assembly gently. If unsure, please contact the factory for assistance.*

#### 4.4 HANDHELD OR PROBE TIP MOUNT

This method is NOT recommended for most applications. It is generally used where access to machinery may be a safety concern. Both the accuracy and repeatability at low (<5 Hz) and high frequency (>1 kHz) ranges are questionable.

#### 5.0 CABLING

The selection of connectors and cables has a direct impact on the ruggedness and reliability of the sensor installation. A consideration when dealing with cables is the way in which the cable conductors are terminated.

ICP® accelerometers are internally amplified, two-wire accelerometers. Connections to the sensor require two leads: one for the power and signal, and the other for the common and signal return. Often, coaxial cables are used since only two conductors are needed. Coaxial cables are less expensive. With coaxial cables, however, erroneous signals can be introduced into sensor systems through ground loops, electromagnetic interference, or radio frequency interference (EMI or RFI). To avoid ground loops, there should only be one ground in the system.

It is recommended for permanent installations that the sensor be case-isolated and internally shielded with a dual-case design and use a two-conductor shielded cable to insure clean vibration signal transmission. Two-conductor shielded cables allow the signal and the signal return (common) to be fully shielded from the sensor to the readout equipment. To insure that ground loop signals are not induced, the shield should only be terminated at one end. Typically, the shield of a two-conductor shielded cable is left open or not connected at the sensor end and is tied to earth ground at the instrumentation end.

Operation over long cables may affect the frequency response of ICP® accelerometers, and introduce low frequency noise and high frequency distortion when an insufficient current is available to drive cable capacitance.

Unlike charge mode systems, where the system noise is a function of cable length, ICP® sensors provide a high voltage, low impedance output well-suited for driving long cables through harsh environments. While there is virtually no increase in noise with ICP® sensors, the capacitive loading of the longer cable may be distort or filter higher frequency signals depending on the supply current and the output impedance of the sensor.

Generally, this signal distortion is not a problem with lower frequency testing within a range up to 1,000 Hz. However, when monitoring higher frequency vibrations traveling over cables longer than 500ft, the possibility of signal distortion exists.

The maximum frequency that can be transmitted over a given cable length is a function of both the cable capacitance and the ratio of the peak signal voltage to the current available from the signal conditioner according to:



$$f_{\max} = \frac{10^9}{2\pi CV} \quad (\text{Equation 1})$$

[L<sub>c</sub>-1]

Where,  $f_{\max}$  = maximum frequency (hertz)  
C = cable capacitance (picofarads)  
V = maximum peak output from sensor (volts)  
 $L_c$  = constant current from signal conditioner (mA)  
 $10^9$  = scaling factor to equate units

Note that in this equation, 1 mA is subtracted from the total current supplied to sensor ( $L_c$ ). This is done to compensate for powering the internal electronics. Also, note that these are typical values only.

When driving long cables, Equation 1 shows that, as the length of the cable, peak voltage output or maximum frequency of interest increases, a greater constant current will be required to drive the signal.

The nomograph on page 12 of this manual provides a simple, graphical method for obtaining the expected maximum frequency capability of an ICP® measurement system. The maximum peak signal voltage amplitude, cable capacitance and supplied constant current must be known or presumed.

For example, when running at 100 ft (30.5 m) cable with a capacitance of 30 pF/ft, the total capacitance is 3,000pF. This value can be found along the diagonal cable capacitance lines. Assuming the sensor operates at a maximum output range of 5 volts and the constant current available from the power supply is 2 mA, the ratio on the vertical axis can be calculated to equal 5. The intersection of the total cable capacitance and this ratio result in a maximum frequency of approximately 10.2 kHz.

The nomograph does not indicate whether the frequency amplitude response at a point is flat, rising or falling. For precautionary reasons, it is good general practice to increase the constant current (if possible) to the sensor (within its maximum limit) so that the frequency determined from the nomograph is approximately 1.5 to 2 times greater than the maximum frequency of interest.

**Note:** Higher current levels will deplete battery-powered signal conditioners at a faster rate. Also, any current not used by the cable goes directly to power the internal electronics and will create heat. This may cause the sensor to

exceed its maximum temperature specification. For this reason, do not supply excessive current over short cable runs or when testing at elevated temperatures.

### 5.1 CABLE CONNECTOR PROCEDURE

Care and attention to installation is essential, as the reliability and accuracy of your system is no better than that of the output cable.

**STEP 1:** Ascertain that you have ordered the correct cable type.

As with sensors, no cable can satisfy all applications. Special low-noise cabling should be used with high impedance, charge-output devices. ICP® sensors usually operate with any ordinary tow-wire cable. Industrial applications often require twisted/shielded cables to reduce the effects of EMI and RFI. PTFE-jacketed cabling may be necessary to withstand corrosive environments.

**STEP 2:** Connect the cable to the accelerometer. A small amount of thread-locking compound placed on the connector prior to attachment helps secure the cable during testing. In harsh environments, the connection can be sealed with silicone rubber, O-rings, and flexible heat-shrink tubing.

**STEP 3:** Plug the connector of the cable into the mating sensor connector. Then, holding the sensor stationary, secure the connector in place by tightening down the attached threaded cable sleeve.

**STEP 4:** Route the cable to the signal conditioner, making certain to stress-relieve the sensor/cable connection and minimize motion by clamping the cable at regular intervals.

Common sense should be used to avoid physical damage and minimize electrical noise. For instance, avoid routing cables near high-voltage wires. Do not route cables along floors or walkways where they be stepped on or become contaminated. Shielded cables should have the shield grounded at one end only, normally at the instrumentation end.

**STEP 5:** Finally, connect the remaining cable end to the signal conditioner or readout device. To dissipate charge that may have accumulated in the cable short the signal to ground prior to attachment.

### 6.0 POWERING

All ICP® sensors require constant current excitation for proper operation. For this reason only use approved constant-current sources. A typical system schematic is shown in Figure 11.



Figure 11. Typical System Schematic

The power supply consists of a regulated 18 to 30 VDC source. In general, battery-powered devices offer versatility for portable, low-noise measurements, whereas line-powered units provide the capability for continuous monitoring. This power is regulated by a current-limiting circuit, which provides the constant-current excitation required for proper operation of sensors with integral electronics.

**Note:** Under no circumstances should a voltage be supplied to an ICP® accelerometer without a current-regulating diode or equivalent electrical circuit.

A capacitor at the output stage of the device removes the sensor output bias voltage from the measurement signal. This provides a zero-based, AC-coupled output compatible with most standard readout devices.

Today, many FFT analyzers, data acquisition modules, and data collectors have constant-current excitation for direct use with ICP® sensors. However, before using this feature, check that the supply voltage and constant current are adequate for use with your sensor. Please contact the respective signal conditioner manufacturer or check the product manual for more information.

### 7.0 OPERATING

After completing the system setup, switch on the conditioner, the meter (or LED) and allow the sensor to power up. If a faulty condition is monitored, first check all system connections, then check the functionality of the cable and signal conditioner. If

the system still does not operate properly, consult an IMI Application Engineer.

**Note:** Always operate the accelerometer within the limitations listed on the Specification Sheet of your sensor. Operating the device outside of its parameters can cause temporary or permanent damage to the sensor.

### 8.0 ACCELEROMETER CALIBRATION

**Note:** It is good measurement practice to verify the performance of each accelerometer before and after each measurement.

Accelerometers are precision measuring instruments. They are highly engineered to provide accurate electrical signals representative of the vibration being monitored. Each sensor is calibrated by comparison to a known acceleration level. Some calibrations include frequency response curves, resonant frequency measurements, transvers sensitivity, and many other valuable tests. Applications requiring a high degree of accuracy or those in plants requiring certification and traceability require full calibration test results.



Figure 12. Typical Calibration Certificate

Some applications have much less stringent requirements for calibration certification. Simple sensitivity measurements at a single frequency may be sufficient; operational verification and certificates of conformance to published specifications may satisfy many plants' calibration needs. Reducing the final calibration requirements reduces the cost of manufacturing the sensor and should lower the price for predictive maintenance users.

Periodic recalibration may be required by plants with strict certification and traceability requirements. It is always recommended that the user has the sensor recalibrated periodically, particularly if the sensor has experienced a very high shock level or extreme temperatures for extended periods of time. Some plants develop in-house calibration capabilities for periodically verifying the performance of accelerometers. Products are available that provide a set 1 g-acceleration level at a fixed frequency for quick sensor checking.

For these reasons, it is recommended that a recalibration cycle be established for each accelerometer. This schedule is unique and is based on a variety of factors, such as extent of use, environmental conditions, accuracy requirements, trend information obtained from previous calibration records, contractual regulations, frequency of “cross-checking” against other equipment, manufacturer recommendation, and any risk associated with incorrect readings. International standards, such as ISO 10012-1, provide insight and suggested methods for determining recalibration intervals for most measuring equipment. With the above information in mind and under “normal” circumstances, a conservative suggestion of 12 to 24 month recalibration cycle for most piezoelectric accelerometers is advised.

**8.1 SENSOR CALIBRATION**

Accelerometer recalibration services are typically performed by IMI’s internal metrology laboratory. (Other international and private laboratories are also available.) The IMI laboratory is certified to ISO 9001, complies with ISO 10012-1 (and former MIL-STD-45662A), and uses equipment directly traceable to NIST. This assures an accurate calibration of relevant specifications.

The following includes a broad overview of the Back-to-Back Calibration technique normally used when calibrating accelerometers. This technique provides a quick and easy method for determining the sensitivity of a test accelerometer over a wide frequency range.

**8.2 BACK-TO-BACK CALIBRATION THEORY**

Back-to-back calibration is perhaps the most common method for determining the sensitivity of

piezoelectric accelerometers. This method relies on a simple comparison to a previously calibrated accelerometer, typically referred to as a reference standard, as shown in Figure 12.



**Figure 12.** Reference Standard Accelerometer

These high-accuracy devices, which are directly traceable to a recognized standards laboratory, are designed for stability, as well as configured to accept a test accelerometer. By mounting a test accelerometer to the reference standard and then connecting this combination to a suitable vibration source, it is possible to vibrate both devices and compare the data as shown in Figure 13. (Test setups may be automated and vary, depending on the type and number for accelerometers being calibrated.)



**Figure 13.** Typical Back-to-Back Calibration System

Because the acceleration is the same on both sensors, the ratio of their outputs ( $V_T/V_R$ ) must also be the ratio of their sensitivities. With the sensitivity of the reference standard ( $S_R$ ) known, the exact sensitivity of the test sensor ( $S_T$ ) is easily calculated by using the following equation:

$$S_T = S_R \left( \frac{V_T}{V_R} \right)$$

By varying the frequency of the vibration, the sensor may be calibrated over its entire operating frequency range. The typical response of an unfiltered accelerometer is shown in Figure 14.



Figure 14. Typical Test Accelerometer Response

**9.0 TROUBLESHOOTING**

Piezoelectric sensors are dynamic measuring equipment. They use piezoelectric sensing elements to convert or transduce the mechanical phenomena to an electrical signal. The mechanical parameter may be force, pressure or vibration. The raw electrical signal from a piezoelectric charge element is a high impedance signal. This charge signal is normally converted to a low impedance voltage signal by either an external charge amplifier or an external voltage amplifier. The cables between the charge sensor and the amplifier must be high quality, low noise cable and must be kept as short as possible. Figure 15 shows a typical high impedance system.



Figure 15. High Impedance System Connection

Internally amplified sensors employ miniature amplifiers to convert the high impedance charge signal into a low impedance voltage signal. These amplifiers are internal to the sensor, and therefore, do not require low noise cables or external amplifiers. These amplifiers have set gain so that output sensitivities are standardized.



Figure 16. Sensor with Integral Electronics System Connector

ICP® sensors are two-wire sensors. They are powered with a constant current DC source. The power supply is typically 18 to 30 volts DC current limited via a constant current between 2 and 20 mA. Typical battery operated supplies offer 2mA of constant current to extend battery life while continuous monitoring systems offer more current in order to drive longer cables. Figure 16 shows a typical system for a sensor with integral electronics.

The signal output of a sensor with integral electronics is a low impedance voltage signal proportional to the dynamic measurement such as force, pressure, or vibration. This voltage signal is carried on a DC bias voltage. The AC dynamic signal is superimposed on the DC bias voltage and is allowed to swing between the supply voltage and ground as shown in Figure 17. Unlike an operational amplifier that requires a plus and minus supply and allows the signal to “ride” on ground and “swing” between the plus and minus “rails,” the sensor with integral electronics requires the output signal to be DC biased.



Figure 17. Sensor DC Bias Voltage

This DC bias voltage is an excellent diagnostic tool. The voltage provides a means of verifying that the amplifier is “turned on.” Typical input/output power supplies will block this DC bias voltage at the output via a blocking capacitor in order to AC couple the signal to readout devices. By “teeing” off the input into a DC volt meter, as shown in Figure 18, the bias voltage can be measured.

While measuring the supply voltage, the bias voltage can be measured after the sensor is plugged in. If the meter stays at supply, something in the system is open or not connected. If the meter reads “0,” something in the system is shorted. If the meter reads within the bias voltage range of the sensor, then the sensor and cabling are functioning properly.



**Figure 18.** DC Bias Voltage Measurement

### 10.0 REPAIR/RETURN PROCEDURE

Because of the nature of most IMI instrumentation, field repair is typically NOT recommended and may void any warranty. If factory service is required, contact IMI for a **RETURN MATERIAL AUTHORIZATION (RMA)** number prior to sending equipment to the factory. Please have information available, such as model and serial number. Also, to insure efficient service, be sure to include a written description of the symptoms and problems with the equipment to a local sales representative or distributor, or contact IMI if none are located in your area.

Customers outside the U.S. should consult their local IMI distributor for information on returning equipment. For exceptions, please contact the International Sales department at IMI to request shipping instructions and an

RMA. For assistance, please call **(716) 684-0003**, or fax us at **(716) 684-3823**. You may also receive assistance via e-mail at [imi@pcb.com](mailto:imi@pcb.com) or visit our website at [www.pcb.com](http://www.pcb.com).

### 11.0 CUSTOMER SERVICE/WARRANTY

IMI, a division of PCB Piezotronics, guarantees **Total Customer Satisfaction**. If, at any time, for any reason, you are not completely satisfied with any IMI product, IMI will repair, replace or exchange it at no charge. You may also choose to have your purchase price refunded.





IMI instrumentation is warranted against defective material workmanship for 1 year unless otherwise expressly specified. Damage to instruments caused by incorrect power or misapplication, is not covered by warranty. *If there are any questions regarding power, intended application, or general usage, please consult with your local sales contact or distributor.* Batteries or expendable hardware items are not covered by warranty.

IMI offers to all customers, at no charge, 24-hour phone support. This service makes product or application support available to our customers, day or night, seven days a week. When unforeseen problems or emergency situations arise, call the **IMI Hot Line at (716) 684-0003**, and an application specialist will assist you.

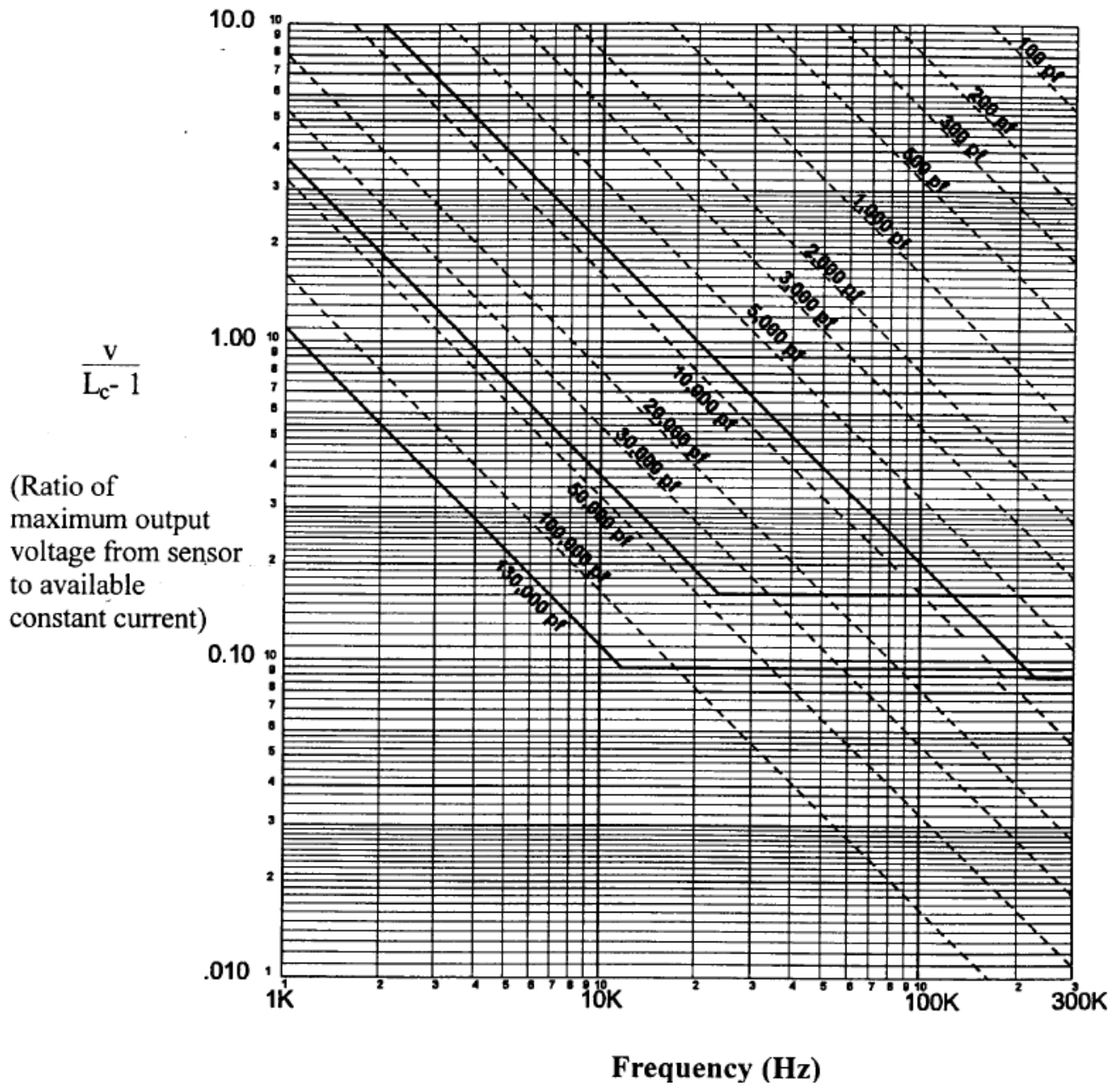

### Cable Driving Nomograph

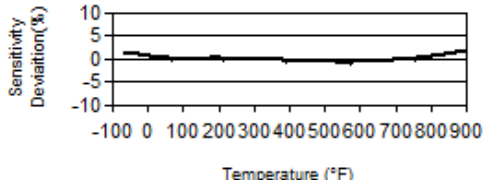

|   |   |   |   |   |             |               |           |               |              |                 |                 |                 |                 |              |
|---|---|---|---|---|-------------|---------------|-----------|---------------|--------------|-----------------|-----------------|-----------------|-----------------|--------------|
| Model Number<br><b>EX600B13</b>   | <b>VERY HIGH TEMPERATURE INDUSTRIAL ICP® ACCELEROMETER</b>  |   |   | Revision: D<br>ECN #: 46623   |             |               |           |               |              |                 |                 |                 |                 |              |
| <b>Performance</b><br>Sensitivity(± 5 %)<br>Measurement Range(Peak)<br>Frequency Range(± 5 %)<br>Frequency Range(± 10 %)<br>Resonant Frequency<br>Broadband Resolution(1 to 10,000 Hz)<br>Non-Linearity<br>Transverse Sensitivity   | <b>ENGLISH</b><br>100.0 mV/g<br>± 50 g<br>282 to 210,000 cpm<br>204 to 300,000 cpm<br>1200 kcpm<br>450 µg<br>± 1 %<br><5 %  | <b>SI</b><br>10.2 mV/(m/s <sup>2</sup> )<br>± 490 m/s <sup>2</sup><br>4.7 to 3500 Hz<br>3.4 to 5000 Hz<br>20 kHz<br>4415 µm/sec <sup>2</sup><br>± 1 %<br><5 %   | [2]<br><br>[3][4]<br><br>[1]<br>[1][2]<br>[5]     | <b>OPTIONAL VERSIONS</b><br>Optional versions have identical specifications and accessories as listed for the standard model except where noted below. More than one option may be used.  |             |               |           |               |              |                 |                 |                 |                 |              |
| <b>Environmental</b><br>Overload Limit(Shock)<br>Temperature Range(Accelerometer)<br>Temperature Range(Charge Amplifier)<br>Temperature Response<br>Base Strain Sensitivity   | 1000 g pk<br>-65 to +900 °F<br>-60 to +250 °F<br>See Graph<br>≤ 0.006 g/µε  | 9810 m/s <sup>2</sup> pk<br>-54 to +482 °C<br>-51 to +121 °C<br>See Graph<br>≤ 0.06 (m/s <sup>2</sup> )/µε  | [2]<br><br><br>[1]<br>[2]                         | <b>NOTES:</b><br>[1] Typical value.<br>[2] Conversion Factor 1g = 9.81 m/s <sup>2</sup> .<br>[3] 1Hz = 60 cpm (cycles per minute).<br>[4] The high frequency tolerance is accurate within ±10% of the specified frequency.<br>[5] Zero-based, least-squares, straight line method.<br>[6] See PCB Declaration of Conformance PS116 for details. |             |               |           |               |              |                 |                 |                 |                 |              |
| <b>Electrical</b><br>Settling Time(at 70 °F within 1% of bias)<br>Discharge Time Constant<br>Excitation Voltage<br>Constant Current Excitation<br>Output Impedance<br>Output Bias Voltage<br>Spectral Noise(10 Hz)<br>Spectral Noise(100 Hz)<br>Spectral Noise(1 kHz)<br>Electrical Isolation   | ≤ 1.0 sec<br>≥ .10 sec<br>22 to 28 VDC<br>2.2 to 20 mA<br><1000 Ohm<br>12 to 16 VDC<br>30 µg/√Hz<br>8 µg/√Hz<br>4 µg/√Hz<br>>10 <sup>8</sup> Ohm                            | ≤ 1.0 sec<br>≥ .10 sec<br>22 to 28 VDC<br>2.2 to 20 mA<br><1000 Ohm<br>12 to 16 VDC<br>294 (µm/sec <sup>2</sup> )/√Hz<br>78 (µm/sec <sup>2</sup> )/√Hz<br>39 (µm/sec <sup>2</sup> )/√Hz<br>>10 <sup>8</sup> Ohm | <br><br><br>[1]<br><br>[1][2]<br>[1][2]<br>[1][2] | <b>SUPPLIED ACCESSORIES:</b><br>Model 081A99 Cap Screw (3)<br>Model ICS-1 NIST-traceable single-axis amplitude response calibration from 600 cpm (10 Hz) to upper 5% frequency (1)  |             |               |           |               |              |                 |                 |                 |                 |              |
| <b>Physical</b><br>Size (Diameter x Height)<br>Weight(with cable)<br>Mounting<br>Sensing Element<br>Sensing Geometry<br>Housing Material<br>Sealing<br>Electrical Connector<br>Electrical Connection Position<br>Cable Length<br>Cable Type   | 1.5 in x 0.75 in<br>10.5 oz<br>Through Holes (3)<br>UHT-12™<br>Shear<br>Inconel<br>Welded Hermetic<br>2-Pin MIL-C-5015<br>Side<br>10 ft<br>Integral Hardline                | 38.1 mm x 19.1 mm<br>300 gm<br>Through Holes (3)<br>UHT-12™<br>Shear<br>Inconel<br>Welded Hermetic<br>2-Pin MIL-C-5015<br>Side<br>3 m<br>Integral Hardline  |   | <table border="1"> <tr> <td>Entered: LK</td> <td>Engineer: GJR</td> <td>Sales: JC</td> <td>Approved: BAM</td> <td>Spec Number:</td> </tr> <tr> <td>Date: 3/30/2017</td> <td>Date: 3/30/2017</td> <td>Date: 3/30/2017</td> <td>Date: 3/30/2017</td> <td style="text-align: center;"><b>44818</b></td> </tr> </table>                             | Entered: LK | Engineer: GJR | Sales: JC | Approved: BAM | Spec Number: | Date: 3/30/2017 | Date: 3/30/2017 | Date: 3/30/2017 | Date: 3/30/2017 | <b>44818</b> |
| Entered: LK   | Engineer: GJR   | Sales: JC   | Approved: BAM                                     | Spec Number:  |             |               |           |               |              |                 |                 |                 |                 |              |
| Date: 3/30/2017   | Date: 3/30/2017   | Date: 3/30/2017   | Date: 3/30/2017                                   | <b>44818</b>  |             |               |           |               |              |                 |                 |                 |                 |              |
|  [6]<br><br>  <p>All specifications are at room temperature unless otherwise specified.<br/>         In the interest of constant product improvement, we reserve the right to change specifications without notice.<br/>         ICP® is a registered trademark of PCB Group, Inc.</p> | <p style="text-align: center;"><b>Typical Sensitivity Deviation vs Temperature</b></p>  |   |   |  <p><b>IMI SENSORS</b><br/>         A PCB PIEZOTRONICS DIV.<br/>         3425 Walden Avenue, Depew, NY 14043</p> <p style="text-align: right;"> <b>Phone: 800-959-4464</b><br/> <b>Fax: 716-684-3823</b><br/> <b>E-Mail: imi@pcb.com</b> </p>              |             |               |           |               |              |                 |                 |                 |                 |              |

44819

PCB Piezotronics Inc. claims proprietary rights in the information disclosed hereon. Neither it nor any reproduction thereof will be disclosed to others without the written consent of PCB Piezotronics Inc.

**RELATED DRAWING**

NO MODIFICATIONS PERMITTED WITHOUT THE APPROVAL OF THE AUTHORIZED PERSON

| REVISIONS |                                      |       |
|-----------|--------------------------------------|-------|
| REV       | DESCRIPTION                          | DIN   |
| A         | ADDED CABLE LENGTH & TOLERANCE TABLE | 49810 |

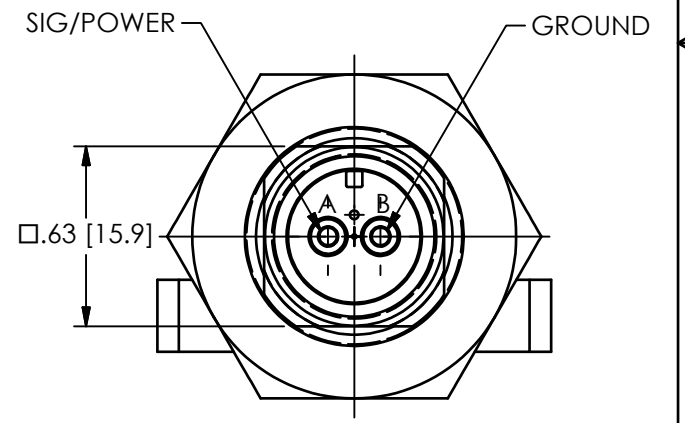
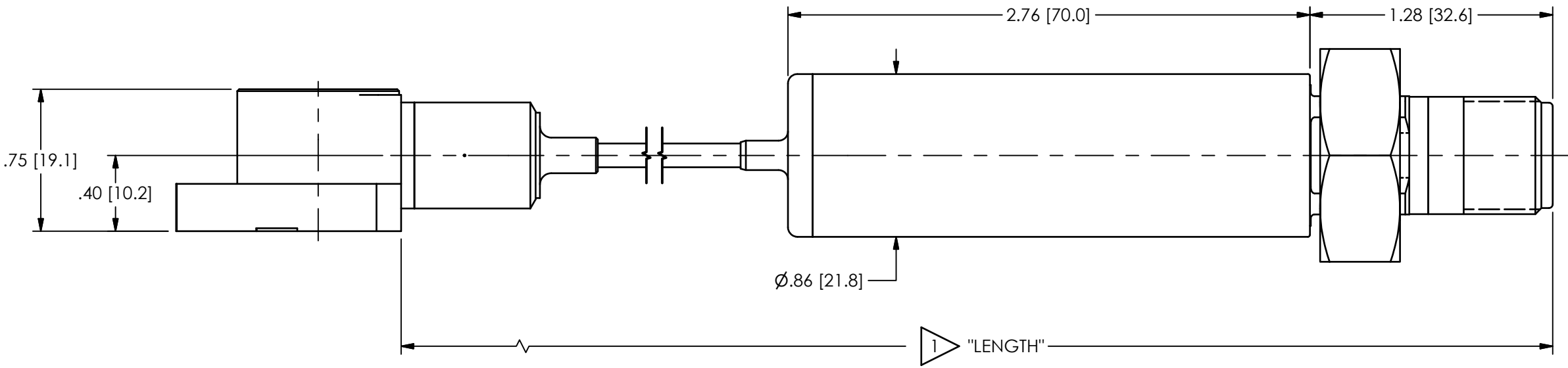
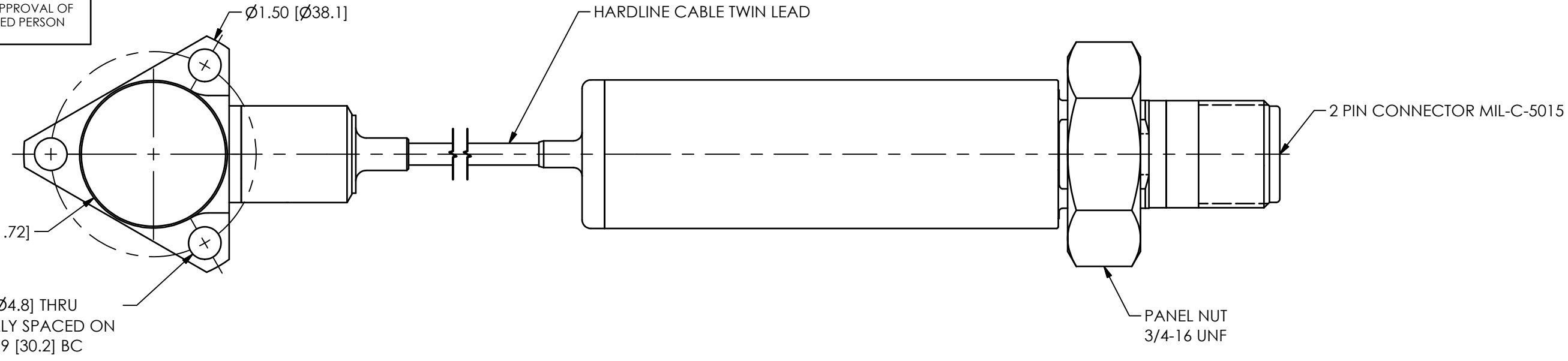

1 LENGTH WILL VARY IN FEET OR METERS DEPENDING ON THE MODEL

| CABLE LENGTH TOLERANCE |           |
|------------------------|-----------|
| LENGTH                 | TOLERANCE |
| 1"-11"                 | +1"/-0"   |
| 1'-4'                  | +4"/-0"   |
| 5'-99'                 | +6"/-0"   |
| 99'+                   | +1"/-0"   |

| UNLESS OTHERWISE SPECIFIED TOLERANCES ARE: |   |
|--|---|
| DIMENSIONS IN INCHES                       | DIMENSIONS IN MILLIMETERS [IN BRACKETS] |
| DECIMALS XX ±.03<br>XXX ±.010              | DECIMALS X ±0.8<br>XX ±0.25             |
| ANGLES ± 2 DEGREES                         | ANGLES ± 2 DEGREES                      |
| FILLETS AND RADII .003 - .005              | FILLETS AND RADII 0.07 - 0.13           |

| DRAWN   |          | CHECKED |          | ENGINEER |          |
|---|----------|---------|----------|----------|----------|
| JES   | 11/14/19 | JDM     | 11/14/19 | JJD      | 11/14/19 |
| TITLE   |          |         |          |          |          |
| OUTLINE DRAWING<br>MODEL EX600XX SERIES<br>HIGH TEMP SENSOR |          |         |          |          |          |

**PCB PIEZOTRONICS™**  
 3425 WALDEN AVE. DEPEW, NY 14043  
 (716) 684-0001 E-MAIL: sales@pcb.com

|                          |                   |
|--------------------------|-------------------|
| CODE IDENT. NO.<br>52681 | DWG. NO.<br>44819 |
| SCALE: 1.5X              | SHEET 1 OF 1      |



**LCIE**

**1 ATTESTATION D'EXAMEN CE DE TYPE**

**2 Appareil ou système de protection** destiné à être utilisé en atmosphères explosibles (**Directive 94/9/CE**)

**3** Numéro de l'attestation d'examen CE de type  
**LCIE 11 ATEX 3074 X**

**4** Appareil ou système de protection :  
                                  Capteur de vibrations  
Type : EX600XXX

**5** Demandeur : IMI  
Adresse : A PCB Piezotronics Div.  
          3425 Walden Avenue  
          Depew, New York, 14043 USA

**6** Fabricant : IMI  
Adresse : A PCB Piezotronics Div.  
          3425 Walden Avenue  
          Depew, New York, 14043 USA

**7** Cet appareil ou système de protection et ses variantes éventuelles acceptées sont décrits dans l'annexe de la présente attestation et dans les documents descriptifs cités en référence.

**8** Le LCIE, organisme notifié sous la référence 0081 conformément à l'article 9 de la directive 94/9/CE du Parlement européen et du Conseil du 23 mars 1994, certifie que cet appareil ou système de protection est conforme aux exigences essentielles de sécurité et de santé pour la conception et la construction d'appareils et de systèmes de protection destinés à être utilisés en atmosphères explosibles, données dans l'annexe II de la directive. Les résultats des vérifications et essais figurent dans le rapport confidentiel N°107254/612911/1.

**9** Le respect des exigences essentielles de sécurité et de santé est assuré par la conformité à :  
- EN 60079-0 (2009), EN 60079-11 (2007)

**10** Le signe X lorsqu'il est placé à la suite du numéro de l'attestation, indique que cet appareil ou système de protection est soumis aux conditions spéciales pour une utilisation sûre, mentionnées dans l'annexe de la présente attestation.

**11** Cette attestation d'examen CE de type concerne uniquement la conception et la construction de l'appareil ou du système de protection spécifié, conformément à l'annexe III de la directive 94/9/CE. Des exigences supplémentaires de la directive sont applicables pour la fabrication et la fourniture de l'appareil ou du système de protection. Ces dernières ne sont pas couvertes par la présente attestation.

**12** Le marquage de l'appareil ou du système de protection doit comporter les informations détaillées au point 15.

**1 EC TYPE EXAMINATION CERTIFICATE**

**2** **Equipment or protective system** intended for use in potentially explosive atmospheres (**Directive 94/9/EC**)

**3** EC type examination certificate number  
**LCIE 11 ATEX 3074 X**

**4** Equipment or protective system :  
                                  Vibrations sensor  
Type : EX600XXX

**5** Applicant : IMI  
Address : A PCB Piezotronics Div.  
          3425 Walden Avenue  
          Depew, New York, 14043 USA

**6** Manufacturer : IMI  
Address : A PCB Piezotronics Div.  
          3425 Walden Avenue  
          Depew, New York, 14043 USA

**7** This equipment or protective system and any acceptable variation thereto are specified in the schedule to this certificate and the documents therein referred to.

**8** LCIE, notified body number 0081 in accordance with article 9 of the Directive 94/9/EC of the European Parliament and the Council of 23 March 1994, certifies that this equipment or protective system has been found to comply with the essential Health and Safety Requirements relating to the design and construction of equipment and protective systems intended for use in potentially explosive atmospheres, given in Annex II to the Directive. The examination and test results are recorded in confidential report N°107254/612911/1.

**9** Compliance with the Essential Health and Safety Requirements has been assured by compliance with :  
- EN 60079-0 (2009), EN 60079-11 (2007)

**10** If the sign X is placed after the certificate number, it indicates that the equipment or protective system is subject to special conditions for safe use specified in the schedule to this certificate.

**11** This EC type examination certificate relates only to the design and construction of this specified equipment or protective system in accordance with annex III to the directive 94/9/EC. Further requirements of the directive apply to the manufacturing process and supply of this equipment or protective system. These are not covered by this certificate.

**12** The marking of the equipment or protective system shall include information as detailed at 15.

Fontenay Aux Roses

13 SEP. 2011

Seul le texte en français peut engager la responsabilité du LCIE. Ce document ne peut être reproduit que dans son intégralité, sans aucune modification  
The LCIE's liability applies only on the French text. This document may only be reproduced in its entirety and without any change



Le responsable de certification ATEX  
ATEX certification manager

Marc GILLAUX

**13 ANNEXE****13 SCHEDULE****14 ATTESTATION D'EXAMEN CE DE TYPE****14 EC TYPE EXAMINATION CERTIFICATE**

LCIE 11 ATEX 3074 X

LCIE 11 ATEX 3074 X

**15 DESCRIPTION DE L'APPAREIL OU DU SYSTEME DE PROTECTION****15 DESCRIPTION OF EQUIPMENT OR PROTECTIVE SYSTEM**Capteur de vibrations  
Type : EX600XXXVibrations sensor  
Type : EX600XXX

L'appareil utilise un cristal piézoélectrique pour convertir une mesure de vibrations mécaniques en un signal électrique.

L'appareil est composé des éléments suivants :

- un capteur déporté,
  - un câble métallique (longueur max 10m)
  - un boîtier cylindrique métallique contenant une carte électronique enrobée (amplificateur de charge).
- Le câble est soudé d'un côté sur le capteur et de l'autre sur le boîtier de l'amplificateur de charge

The apparatus uses a piezoelectric crystal to convert a mechanical vibration measurement into electrical signal. The equipment is made of following parts :

- a remote sensor,
  - a metallic cable (length 10m max.),
  - a metallic cylindrical box, including an encapsulated electronic board (charge amplifier).
- The cable is welded to the sensor and to the box of the charge amplifier.

Paramètres spécifiques du ou des modes de protection concernés : $U_i \leq 28V, I_i \leq 120mA, P_i \leq 1W, C_i = 0, L_i = 0$ Specific parameters of the concerned protection mode : $U_i \leq 28V, I_i \leq 120mA, P_i \leq 1W, C_i = 0, L_i = 0$ Le marquage doit être :

IMI

Adresse : ...

Type : EX600XXX

N° de fabrication : ...

Année de fabrication : ...

Ex ia IIC Ga

T4, Ta = +121°C (électronique)

T1, Ta = +440°C (capteur et câble)

LCIE 11 ATEX 3074 X

 $U_i \leq 28V, I_i \leq 120mA, P_i \leq 1W, C_i = 0, L_i = 0$ 

L'appareil doit également comporter le marquage normalement prévu par les normes de construction qui le concerne.

The marking shall be :

IMI

Address : ...

Type : EX600XXX

Serial number : ...

Year of construction : ...

Ex ia IIC Ga

T4, Ta = +121°C (electronic)

T1, Ta = +440°C (sensor and cable)

LCIE 11 ATEX 3074 X

 $U_i \leq 28V, I_i \leq 120mA, P_i \leq 1W, C_i = 0, L_i = 0$ 

The equipment shall also bear the usual marking required by the manufacturing standards applying to such equipment.

**16 DOCUMENTS DESCRIPTIFS**

Dossier de certification N°49507 rév.NR du 24/06/11.  
Ce document comprend 6 rubriques (10 pages).

**16 DESCRIPTIVE DOCUMENTS**

Certification file N°49507 rev.NR dated 24/06/11.  
This file includes 6 items (10 pages).



LCIE



**13 ANNEXE (suite)**

**13 SCHEDULE (continued)**

**14 ATTESTATION D'EXAMEN CE DE TYPE**

**14 EC TYPE EXAMINATION CERTIFICATE**

LCIE 11 ATEX 3074 X

LCIE 11 ATEX 3074 X

**17 CONDITIONS SPECIALES POUR UNE UTILISATION SÛRE**

**17 SPECIAL CONDITIONS FOR SAFE USE**

L'appareil ne peut être raccordé qu'à des équipements certifiés de sécurité intrinsèque ou conforme aux exigences du paragraphe 5.7 de la norme EN 60079-11. Ces associations doivent être compatibles vis-à-vis de la sécurité intrinsèque (voir les paramètres électriques au paragraphe 15).

The equipment can be only connected to intrinsically safe certified equipment or according to the requirements of clause 5.7 EN 60079-11 standard. These combinations must be compatible as regard the intrinsic safety rules (see electrical parameters clause 15).

**18 EXIGENCES ESSENTIELLES DE SECURITE ET DE SANTE**

**18 ESSENTIAL HEALTH AND SAFETY REQUIREMENTS**

Couvertes par les normes listées au point 9.

Covered by standards listed at 9.

**19 VERIFICATIONS ET ESSAIS INDIVIDUELS**

**19 ROUTINE VERIFICATIONS AND TESTS**

Néant.

None.

**20 CONDITIONS DE CERTIFICATION**

**20 CONDITIONS OF CERTIFICATION**

Les détenteurs d'attestations d'examen CE de type doivent également satisfaire les exigences de contrôle de production telles que définies à l'article 8 de la directive 94/9/CE.

Holders of EC type examination certificates are also required to comply with the production control requirements defined in article 8 of directive 94/9/EC.

## EU Declaration of Conformity PS116

In Accordance with ISO/IEC 17050

|  |  |
|--|--|
| <b>Manufacturer:</b> PCB Piezotronics, Inc.<br>3425 Walden Avenue<br>Depew, New York 14043 USA | <b>Authorized European Representative:</b> PCB Piezotronics Europe GmbH<br>Porschestraße 20-30<br>41836 Hückelhoven, Germany |
|--|--|

**Certifies that type of equipment:** ICP® Vibration Sensor(s)

**Whose Product Models Include:** EX600XXX

Note: "XXX" is a place holder for Alpha Numeric Characters (some with an optional /  
 The denote various model configurations

For example: EX600B13 Industrial Vibration Sensor

This declaration is applicable to all Vibration Sensor(s) of the above series which have the CE & (EX) ATEX mark on their data sheets and where those data sheets refer to this declaration of conformity. The data sheets for all model numbers referenced above, which include the CE & (EX) ATEX mark on such data sheets and refer to this Declaration of Conformity are hereby incorporated by reference into this Declaration.

|   |  |   |
|---|--|---|
| <b>Conform to the following EU Directive(s) when installed per product documentation:</b> | 2014/30/EU<br>2014/34/EU<br>2011/65/EU w/2015/863/EU | EMC Directive<br>ATEX Directive<br>RoHS Directive |
|---|--|---|

### Standards to which Conformity is Declared:

|   |  |   |
|---|--|---|
| <b>Harmonized Standards</b>                                       | EN 61326-1:2013<br>EN 61326-2-3: 2013<br>EN 61010-1:2010<br><br>EN 60079-0:2018<br><br>EN 60079-11:2012<br>EN 60079-15:2010<br>EN 63000:2018                 | Electrical Equipment for Measurement, Control and Laboratory Use- EMC<br>Electrical Equipment for Measurement, Control and Laboratory Use- EMC<br>Safety and EMC requirements for electrical equipment in a laboratory setting.<br>General Explosive Atmosphere<br><br>Intrinsic safe, i<br>Non-sparking, n<br>Technical documentation for the assessment of electrical and electronic products with respect to the restriction of hazardous substances |
| <b>Emissions Test Standards</b>                                   | EN 55011:2009+<br>A1:2010  | Industrial, scientific and medical (ISM) radio frequency equipment-<br>Electromagnetic disturbance characteristics- Limits and methods of<br>Measurement Class B  |
| <b>Other Standards Applied (non-OJEU) Immunity Test Standards</b> | EN 61000-4-2:2009<br>EN 61000-4-3:2006+<br>A2:2010<br>EN 61000-4-4:2012<br>EN 61000-4-5:2014<br>EN 61000-4-6:2014<br>EN 61000-4-8:2010<br>EN 61000-4-11:2004 | Electrostatic discharge (ESD)<br>Radiated, radio-frequency, electromagnetic field immunity<br><br>Electrical fast transient (EFT) / Burst immunity<br>Surge immunity<br>Immunity to RF conducted line disturbances<br>Power frequency magnetic field immunity<br>Voltage Dips, Short Interruptions and Voltage Variations Immunity  |
| <b>Test Reports</b>   | EMC Reports<br>Safety Reports  | GM29045c<br>GM29046s  |
| <b>EC Type Examination</b>  | ATEX Certification   | LCIE 11 ATEX 3074 X<br><br>Ex ia IIC Ga T4, II 1G<br>Ex ia IIC Ga T1, II 1G   |
| <b>Voluntary Certification</b>                                    | Voluntary Type Examination Certificate   | LCIE 11 ATEX 1007 X<br><br>Ex nA IIC Gc T4, II 3G<br>Ex nA IIC Gc T1, II 3G   |

|                                |  |   |
|--------------------------------|--|---|
| <b>Notified Body Name</b>      |  | Laboratoire Central des Industries Electriques (0081)   |
| <b>Notified Body's Address</b> |  | <b>FONTENAY-AUX-ROSES (Head Office)</b><br>33, avenue du Général Leclerc<br>FR- 92260 Fontenay-aux-Roses<br>Tel. : + 33 1 40 95 60 60<br>Fax : + 33 1 40 95 86 56 |

*I, the undersigned, hereby declare that the equipment specified above conforms to the above Directive(s) Standard(s)*

**Place:** Depew, NY **Date:** 04/04/2022

Signature:



Name:

Carrie Termin

Title:

Regulatory Affairs and Product Certification Specialist





**L C I E**

**1 ATTESTATION D'EXAMEN DE TYPE VOLONTAIRE**

2 **Appareil** destiné à être utilisé en atmosphères explosibles (Directive 94/9/CE)

3 Numéro de l'attestation d'examen de type LCIE 11 ATEX 1007 X

4 Appareil  
Capteur de vibrations  
Type : EX600XXX

5 Demandeur : IMI  
Adresse : A PCB Piezotronics Div.  
3425 Walden Avenue  
Depew, New York, 14043 USA

7 Cet appareil ou système de protection et ses variantes éventuelles acceptées sont décrits dans l'annexe de la présente attestation et dans les documents descriptifs cités en référence.

8 Le LCIE certifie que cet appareil ou système de protection est conforme aux exigences essentielles de sécurité et de santé pour la conception d'appareils ou système de protection, électriques de catégorie 3 ou non électriques de catégorie 2 et 3, destinés à être utilisés en atmosphères explosibles, données dans l'annexe II de la directive 94/9/CE du Parlement européen et du Conseil du 23 mars 1994.

Les résultats des vérifications et essais figurent dans le rapport confidentiel N°107254/612911/2.

9 Le respect des exigences essentielles de sécurité et de santé est assuré par la conformité à :

- EN 60079-0 (2009), EN 60079-15 (2010)

10 Le signe X lorsqu'il est placé à la suite du numéro de l'attestation, indique que cet appareil ou système de protection est soumis aux conditions spéciales pour une utilisation sûre, mentionnées dans l'annexe de la présente attestation.

11 Cette attestation d'examen de type concerne uniquement la conception, les vérifications et essais de l'appareil ou du système de protection spécifié, conformément à la directive 94/9/CE.

Des exigences supplémentaires de la directive sont applicables pour la fabrication et la fourniture de l'appareil ou du système de protection. Ces dernières ne sont pas couvertes par la présente attestation.

12 Le marquage de l'appareil ou du système de protection doit comporter les informations détaillées au point 15.

**1 VOLUNTARY TYPE EXAMINATION CERTIFICATE**

2 **Equipment** intended for use in potentially explosive atmospheres (Directive 94/9/EC)

3 Type Examination Certificate number LCIE 11 ATEX 1007 X

4 Equipment  
Vibrations sensor  
Type : EX600XXX

5 applicant : IMI  
Address : A PCB Piezotronics Div.  
3425 Walden Avenue  
Depew, New York, 14043 USA

7 This equipment or protective system and any acceptable variation thereto is specified in the schedule to this certificate and the documents therein referred to.

8 LCIE certifies that this equipment or protective system has been found to comply with the essential Health and Safety Requirements that relate to the design of equipment or protective system, of category 3 electrical or categories 2 and 3 non electrical, which is intended for use in potentially explosive atmospheres, given in Annex II of the Directive 94/9/EC of the European Parliament and Council of 23 March 1994.

The examination and test results are recorded in confidential report N°107254/612911/2.

9 Compliance with the Essential Health and Safety Requirements has been assured by reference to :

- EN 60079-0 (2009), EN 60079-15 (2010)

10 If the sign X is placed after the certificate number, it indicates that the equipment or protective system is subject to special conditions for safe use specified in the schedule to this certificate.

11 This type examination certificate relates only to the design, examination and tests of this specified equipment or protective system in accordance III to the directive 94/9/EC.

Further requirements of the Directive may apply to the manufacturing process and supply of this equipment or protective system. These are not covered by this certificate.

12 The marking of the equipment or protective system shall include informations as detailed at 15.

Fontenay Aux Roses

13 SEP. 2011

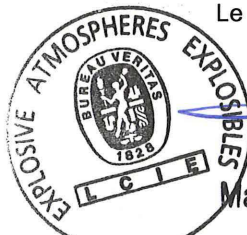

Le responsable de certification ATEX  
ATEX certification manager

Marc GILLAUX

Seul le texte en français peut engager la responsabilité du LCIE. Ce document ne peut être reproduit que dans son intégralité, sans aucune modification  
The LCIE's liability applies only on the French text. This document may only be reproduced in its entirety and without any change

13 ANNEXE

13 SCHEDULE

14 ATTESTATION D'EXAMEN DE TYPE VOLONTAIRE

14 VOLUNTARY TYPE EXAMINATION CERTIFICATE

LCIE 11 ATEX 1007 X

LCIE 11 ATEX 1007 X

15 DESCRIPTION DE L'APPAREIL OU DU SYSTEME DE PROTECTION

15 DESCRIPTION OF EQUIPMENT OR PROTECTIVE SYSTEM

Capteur de vibrations  
Type : EX600XXX

Vibrations sensor  
Type : EX600XXX

L'appareil utilise un cristal piézoélectrique pour convertir une mesure de vibrations mécaniques en un signal électrique.

L'appareil est composé des éléments suivants :

- un capteur déporté,
- un câble métallique (longueur max 10m)
- un boîtier cylindrique métallique contenant une carte électronique enrobée (amplificateur de charge).

Le câble est soudé d'un coté sur le capteur et de l'autre sur le boîtier de l'amplificateur de charge

The apparatus uses a piezoelectric crystal to convert a mechanical vibration measurement into electrical signal.

The equipment is made of following parts :

- a remote sensor,
- a metallic cable (length 10m max.),
- a metallic cylindrical box, including an encapsulated electronic board (charge amplifier).

The cable is welded to the sensor and to the box of the charge amplifier.

Paramètres spécifiques du ou des modes de protection concernés :

Specific parameters of the concerned protection mode :

$U \leq 28V, I \leq 120mA, P \leq 1W$

$U \leq 28V, I \leq 120mA, P \leq 1W$

Le marquage doit être :

IMI  
Adresse : ...  
Type : EX600XXX  
N° de fabrication : ...  
Année de fabrication : ...  
⊕ II 3G  
Ex nA IIC Gc  
T4, Ta = +121°C (électronique)  
T1, Ta = +440°C (capteur et câble)  
LCIE 11 ATEX 1007 X

The marking shall be :

IMI  
Address : ...  
Type : EX600XXX  
Serial number : ...  
Year of construction : ...  
⊕ II 3G  
Ex nA IIC Gc  
T4, Ta = +121°C (electronic)  
T1, Ta = +440°C (sensor and cable)  
LCIE 11 ATEX 1007 X

L'appareil doit également comporter le marquage normalement prévu par les normes de construction qui le concerne.

The equipment shall also bear the usual marking required by the manufacturing standards applying to such equipment.

16 DOCUMENTS DESCRIPTIFS

Dossier technique N°49505 rév.NR du 24/06/11/11.  
Ce document comprend 6 rubriques (10 pages).

16 DESCRIPTIVE DOCUMENTS

Technical file N°49505 rev.NR dated 24/06/11.  
This file includes 6 items (10 pages).

17 CONDITIONS SPECIALES POUR UNE UTILISATION SÛRE

Température maximale d'utilisation :  
- boîtier électronique : +121°C (T4)  
- capteur et câble : +440°C (T1)

17 SPECIAL CONDITIONS FOR SAFE USE

Maximum temperature of use :  
- electronic box : +121°C (T4)  
- sensor and cable : +440°C (T1)

18 EXIGENCES ESSENTIELLES DE SECURITE ET DE SANTE

Couvertes par les normes listées au point 9.

18 ESSENTIAL HEALTH AND SAFETY REQUIREMENTS

Covered by standards listed at 9.

19 VERIFICATIONS ET ESSAIS INDIVIDUELS

Néant.

19 ROUTINE VERIFICATIONS AND TESTS

None.

# Certificate of Compliance

**Certificate:** 2397520 (LR 103164)

**Master Contract:** 184981

**Project:** 2397520

**Date Issued:** May 19, 2011

**Issued to:** Industrial Monitoring Instr. (IMI)

A Div. of PCB Piezotronics, Inc.  
3425 Walden Ave  
Depew, NY 14043  
USA  
Attention: Nick Fulciniti

*The products listed below are eligible to bear the CSA Mark shown with adjacent indicators 'C' and 'US' for Canada and US or with adjacent indicator 'US' for US only or without either indicator for Canada only.*



*Edward Foo*

**Issued by:** Edward Foo, C.E.T.

**PRODUCTS**

**CLASS 2258 04** - PROCESS CONTROL EQUIPMENT - Intrinsically Safe, Entity - For Hazardous Locations

**CLASS 2258 84** - PROCESS CONTROL EQUIPMENT - Intrinsically Safe, Entity - - For Hazardous Locations - Certified to US Standards

**Ex ia IIC / AEx ia IIC: Class I, Zone 0:**

**Class I, Div. 1, Groups A, B, C and D; Class II, Div. 1, Groups E, F and G; Class III, Div. 1:**

• High Temperature Vibration Sensor, Model EX600XYY Series, input rated 28 Vdc max, 20 mA max. Intrinsically safe with entity parameters  $U_i = 28V$ ,  $I_i = 120mA$ ,  $P_i = 1W$ ,  $C_i = 0nF$ ,  $L_i = 0\mu H$  when installed per installation Dwg. 48769. Temperature Code T4,  $T_{amb} = 121^\circ C$ .

**CLASS 2258 03** - PROCESS CONTROL EQUIPMENT - Intrinsically Safe and Non-incendive Systems - For Hazardous Locations



**Certificate:** 2397520 (LR 103164)

**Master Contract:** 184981

**Project:** 2397520

**Date Issued:** May 19, 2011

---

**CLASS 2258 83 - PROCESS CONTROL EQUIPMENT - Intrinsically Safe and Non-Incendive Systems - For Hazardous Locations - CERTIFIED TO U.S. STANDARDS**

**Ex nA IIC / AEx nA IIC: Class I, Zone 2:**

**Class I, Div. 2, Groups A, B, C and D:**

• High Temperature Vibration Sensor, Model EX600XYY Series, input rated 28 Vdc max, 20 mA max. Non-Incendive with entity parameters  $U_i = 28V$ ,  $I_i = 120mA$ ,  $P_i = 1W$ ,  $C_i = 0nF$ ,  $L_i = 0\mu H$  when installed per installation Dwg. 48769. Temperature Code T4,  $T_{amb.} = 121^\circ C$ .

**APPLICABLE REQUIREMENTS**

- CAN/CSA C22.2 No. 0-M91 (R2001) - General Requirements - Canadian Electrical Code, Part II
- CSA Std. C22.2 No. 142-M1987 - Process Control Equipment
- CAN/CSA-C22.2 No. 157-92 - Intrinsically Safe and Non-Incendive Equipment for Use in Hazardous Locations
- CSA Std. C22.2 No. 213-M1987 (R1999) - Non-Incendive Electrical Equipment for Use in Class I, Division 2 Hazardous Locations
- CAN/CSA-60079-0:07 - Electrical Apparatus for Explosive Gas Atmospheres, Part 0: General Requirements
- CAN/CSA- E60079-11:02 - Electrical apparatus for explosive gas atmospheres, Part 11: Intrinsic Safety "i"
- CAN/CSA-E60079-15:02 - Electrical Apparatus for Explosive Gas Atmospheres - Part 15: Electrical Apparatus with Type of Protection "n"
- UL Std. No. 913 7th Ed. 2006 - Intrinsically Safe Apparatus and Associated Apparatus for Use in Class I, II and III, Division 1, Hazardous Locations
- ANSI/ISA-12.12.01-2007 - Non-Incendive Electrical Equipment for Use in Class I and II, Division 2 and Class III, Divisions 1 and 2 Hazardous (Classified) Locations
- UL Std. No. 916, 4th Ed. (2007) - Energy Management Equipment
- ANSI/UL 60079-0: 5th Ed. 2009 - Explosive Atmospheres - Part 0: Equipment - General Requirements



**Certificate:** 2397520 (LR 103164)

**Master Contract:** 184981

**Project:** 2397520

**Date Issued:** May 19, 2011

---

ANSI/UL 60079-11: 5th Ed. 2009 - Explosive Atmospheres - Part 11: Equipment Protection by  
Intrinsic Safety “i”

ANSI/UL 60079-15: 3rd Ed. 2009 - Electrical Apparatus for Explosive Gas Atmospheres - Part 15:  
Construction, Test and Marking of Type of Protection “n”.



## *Supplement to Certificate of Compliance*

**Certificate:** 2397520

**Master Contract:** 184981

*The products listed, including the latest revision described below, are eligible to be marked in accordance with the referenced Certificate.*

### **Product Certification History**

---

| <b>Project</b> | <b>Date</b>  | <b>Description</b>   |
|----------------|--------------|--|
| 2397520        | May 19, 2011 | CSAc/us Certification of High Temperature Vibration Sensor, Model EX600XYY Series, for Class I, Divisions 1 and 2, Groups A, B, C & D; Ex ia IIC/AEx IIC; Ex nA IIC/AE nA IIC; Class II, Div. 1, Groups E, F & G; Class III, Div. 1 hazardous locations. |