



Model TLD086C03

**Modally Tuned® Impulse Hammer w/force sensor and tips, 0 to 500 lbf, 10 mV/lbf (2.2 mV/N),
TEDS 1.0**

Installation and Operating Manual

**For assistance with the operation of this product,
contact the PCB Piezotronics, Inc.**

**Toll-free: 716-684-0001
24-hour SensorLine: 716-684-0001
Fax: 716-684-0987
E-mail: info@pcb.com
Web: www.pcb.com**



Repair and Maintenance

PCB guarantees Total Customer Satisfaction through its “Lifetime Warranty Plus” on all Platinum Stock Products sold by PCB and through its limited warranties on all other PCB Stock, Standard and Special products. Due to the sophisticated nature of our sensors and associated instrumentation, **field servicing and repair is not recommended and, if attempted, will void the factory warranty.**

Beyond routine calibration and battery replacements where applicable, our products require no user maintenance. Clean electrical connectors, housings, and mounting surfaces with solutions and techniques that will not harm the material of construction. Observe caution when using liquids near devices that are not hermetically sealed. Such devices should only be wiped with a dampened cloth—never saturated or submerged.

In the event that equipment becomes damaged or ceases to operate, our Application Engineers are here to support your troubleshooting efforts 24 hours a day, 7 days a week. Call or email with model and serial number as well as a brief description of the problem.

Calibration

Routine calibration of sensors and associated instrumentation is necessary to maintain measurement accuracy. We recommend calibrating on an annual basis, after exposure to any extreme environmental influence, or prior to any critical test.

PCB Piezotronics is an ISO-9001 certified company whose calibration services are accredited by A2LA to ISO/IEC 17025, with full traceability to SI through N.I.S.T. In addition to our standard calibration services, we also offer specialized tests, including: sensitivity at elevated or cryogenic temperatures, phase response, extended high or low frequency response, extended range, leak testing, hydrostatic pressure testing, and others. For more information, contact your local PCB Piezotronics distributor, sales representative, or factory customer service representative.

Returning Equipment

If factory repair is required, our representatives will provide you with a Return Material Authorization (RMA) number, which we use to reference any information you have already provided and expedite the repair process. This number should be clearly marked on the outside of all returned package(s) and on any packing list(s) accompanying the shipment.

Contact Information

PCB Piezotronics, Inc.
3425 Walden Ave.
Depew, NY14043 USA
Toll-free: (800) 828-8840
24-hour SensorLine: (716) 684-0001
General inquiries: info@pcb.com
Repair inquiries: rma@pcb.com

For a complete list of distributors, global offices and sales representatives, visit our website, www.pcb.com.

Safety Considerations

This product is intended for use by qualified personnel who recognize shock hazards and are familiar with the precautions required to avoid injury. While our equipment is designed with user safety in mind, the protection provided by the equipment may be impaired if equipment is used in a manner not specified by this manual.

Discontinue use and contact our 24-Hour Sensorline if:

- Assistance is needed to safely operate equipment
- Damage is visible or suspected
- Equipment fails or malfunctions

For complete equipment ratings, refer to the enclosed specification sheet for your product.

Definition of Terms and Symbols

The following symbols may be used in this manual:



DANGER

Indicates an immediate hazardous situation, which, if not avoided, may result in death or serious injury.

**CAUTION**

Refers to hazards that could damage the instrument.

**NOTE**

Indicates tips, recommendations and important information. The notes simplify processes and contain additional information on particular operating steps.

The following symbols may be found on the equipment described in this manual:



This symbol on the unit indicates that high voltage may be present. Use standard safety precautions to avoid personal contact with this voltage.



This symbol on the unit indicates that the user should refer to the operating instructions located in the manual.



This symbol indicates safety, earth ground.



PCB工业监视和测量设备 - 中国RoHS2公布表

PCB Industrial Monitoring and Measuring Equipment - China RoHS 2 Disclosure Table

部件名称	有害物质					
	铅 (Pb)	汞 (Hg)	镉 (Cd)	六价铬 (Cr(VI))	多溴联苯 (PBB)	多溴二苯醚 (PBDE)
住房	0	0	0	0	0	0
PCB板	X	0	0	0	0	0
电气连接器	0	0	0	0	0	0
压电晶体	X	0	0	0	0	0
环氧	0	0	0	0	0	0
铁氟龙	0	0	0	0	0	0
电子	0	0	0	0	0	0
厚膜基板	0	0	X	0	0	0
电线	0	0	0	0	0	0
电缆	X	0	0	0	0	0
塑料	0	0	0	0	0	0
焊接	X	0	0	0	0	0
铜合金/黄铜	X	0	0	0	0	0
本表格依据 SJ/T 11364 的规定编制。						
0：表示该有害物质在该部件所有均质材料中的含量均在 GB/T 26572 规定的限量要求以下。						
X：表示该有害物质至少在该部件的某一均质材料中的含量超出 GB/T 26572 规定的限量要求。						
铅是欧洲RoHS指令2011/65/ EU附件三和附件四目前由于允许的豁免。						

CHINA RoHS COMPLIANCE

Component Name	Hazardous Substances					
	Lead (Pb)	Mercury (Hg)	Cadmium (Cd)	Chromium VI Compounds (Cr(VI))	Polybrominated Biphenyls (PBB)	Polybrominated Diphenyl Ethers (PBDE)
Housing	O	O	O	O	O	O
PCB Board	X	O	O	O	O	O
Electrical Connectors	O	O	O	O	O	O
Piezoelectric Crystals	X	O	O	O	O	O
Epoxy	O	O	O	O	O	O
Teflon	O	O	O	O	O	O
Electronics	O	O	O	O	O	O
Thick Film Substrate	O	O	X	O	O	O
Wires	O	O	O	O	O	O
Cables	X	O	O	O	O	O
Plastic	O	O	O	O	O	O
Solder	X	O	O	O	O	O
Copper Alloy/Brass	X	O	O	O	O	O

This table is prepared in accordance with the provisions of SJ/T 11364.

O: Indicates that said hazardous substance contained in all of the homogeneous materials for this part is below the limit requirement of GB/T 26572.

X: Indicates that said hazardous substance contained in at least one of the homogeneous materials for this part is above the limit requirement of GB/T 26572.

Lead is present due to allowed exemption in Annex III or Annex IV of the European RoHS Directive 2011/65/EU.

Installation and Operating Manual

ICP[®] Modal / Impulse Force Hammer

CONTENTS:

Introduction.....	1.0
Description.....	2.0
Installation and Operation.....	3.0
Testing	4.0
Calibration	5.0
Maintenance.....	6.0
Precautions	7.0
Warranty and Service	8.0



1.0 INTRODUCTION

The ICP[®] Modal / Impulse Force Hammer adapts your FFT analyzer for structural behavior testing. Impulse testing of the dynamic behavior of mechanical structures involves striking the test object with the force-instrumented hammer, and measuring either the resultant motion with an accelerometer or the acoustic signature with a microphone. Structures generally respond as (1) rigid or elastic bodies, (2) finite elements, lumped constant models and (3) distributed parameter models conducting stress-strain (sound) waves.

Testing the functional transfer and transactional characteristics of a mechanical structure involves mounting the accelerometer at one location of interest and striking the test object with the hammer. Modal analysis and modeling involves fixing the accelerometer(s) at one location, impacting the structure at one point and then moving the accelerometer(s) to other points of interest. Integration of the acceleration signal yields velocity compliance, impedance and mobility. The hammer impulse consists of a nearly-constant force over a broad frequency range, and is therefore capable of exciting all resonances in that range. The hammer, size, length, material and velocity at impact determine the amplitude and frequency content (wave shape) of the force impulse. The impact cap material generally determines energy content. The force spectrums of an impact on a stiff steel mass for hammers with their available tips are shown below.

PCB[®] impulse hammers are available in sizes ranging from the mini-impulse hammer to the 12 lb sledgehammer. All sensors in this system are classified as ICP[®] (Integrated Circuit Piezoelectric), low impedance, voltage-mode sensors. Microelectronic, built-in amplifiers standardize sensitivities within a few percent of nominal value, which is adequate for most dynamic applications.

086E80 Family Impulse Hammer Response Curves

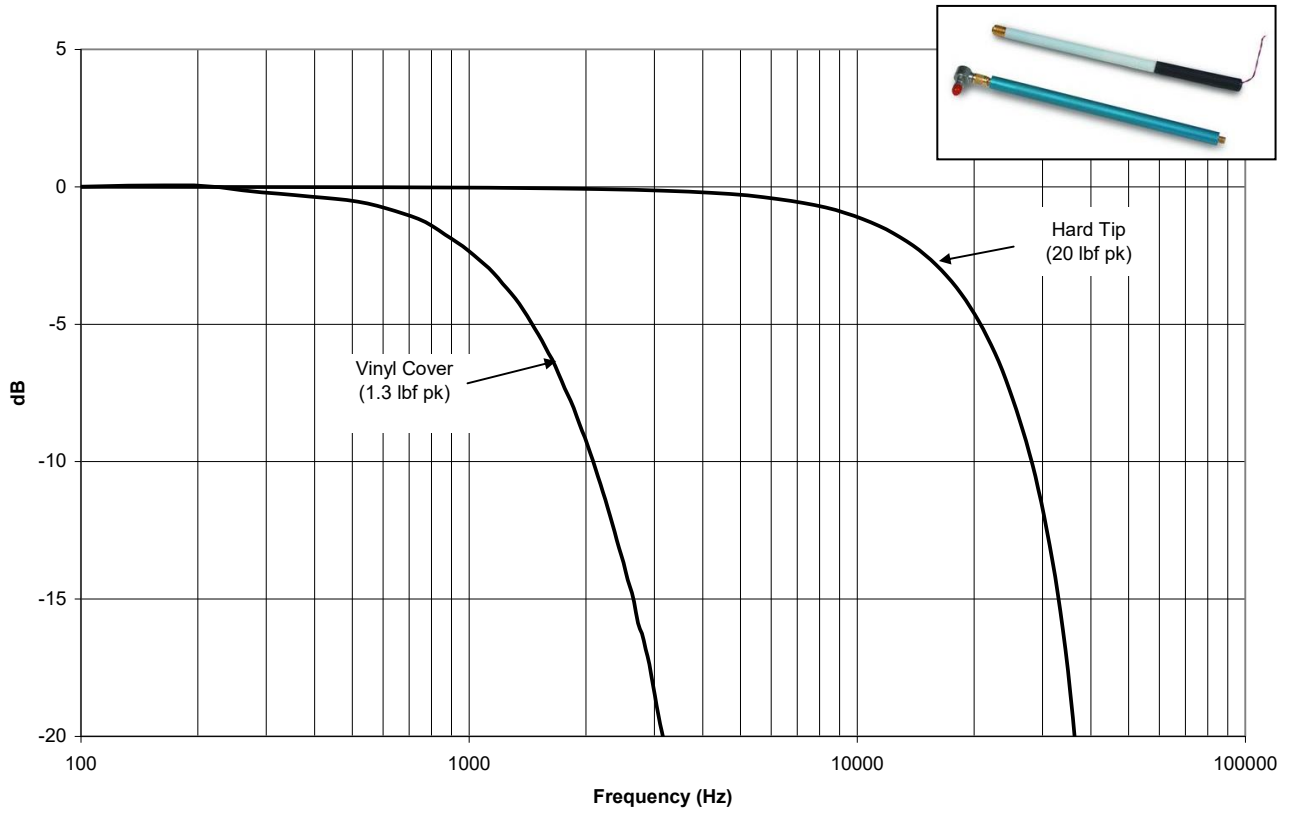

086C01 Family Impulse Hammer Response Curve

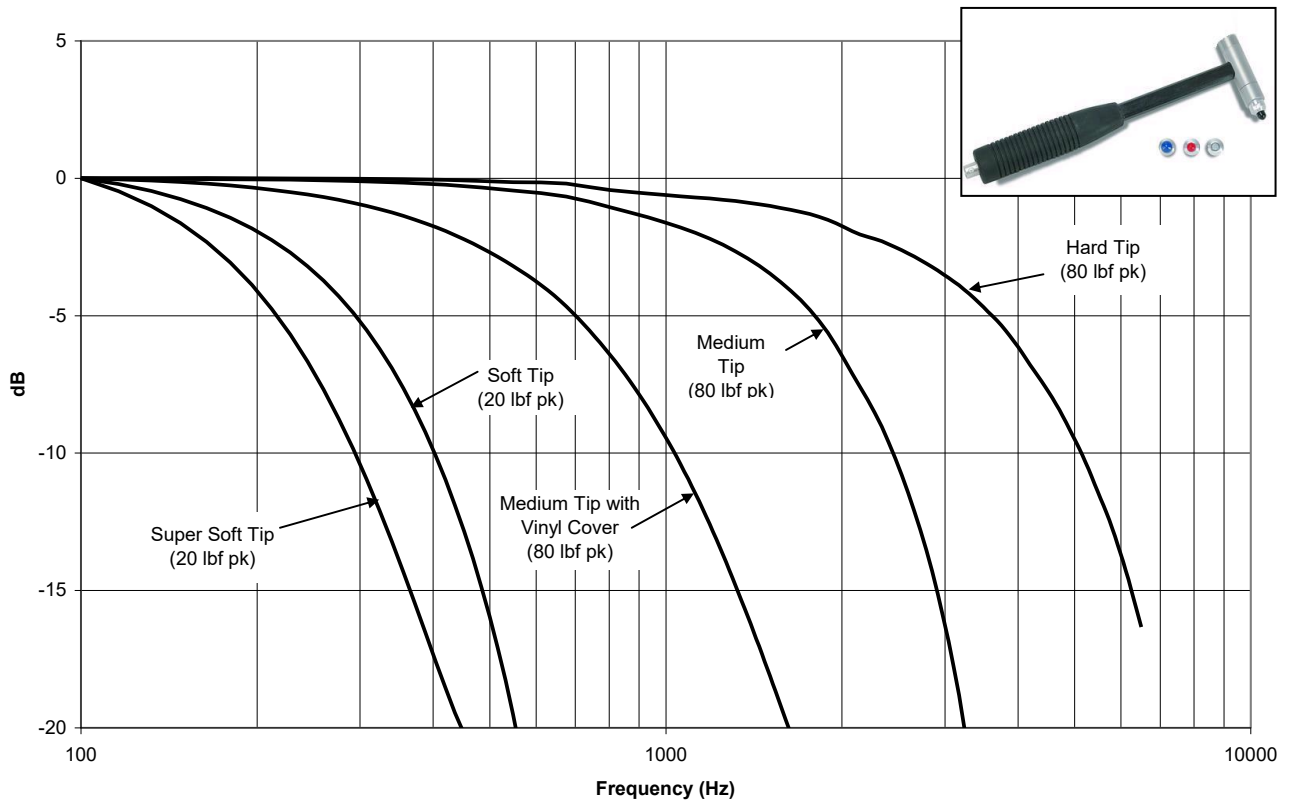

086C02, C03, C04, C40 Family Impulse Hammer Response Curves

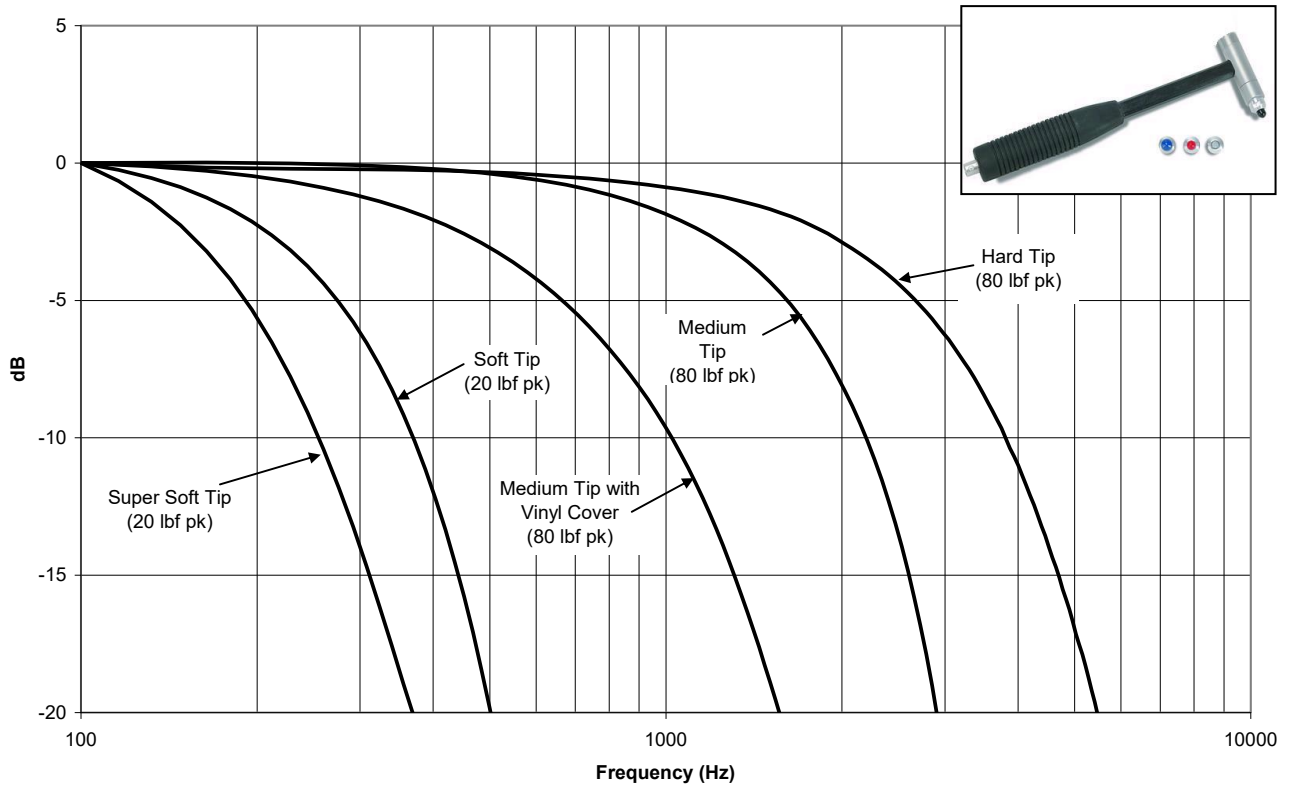

086D05 Family Impulse Hammer Response Curves

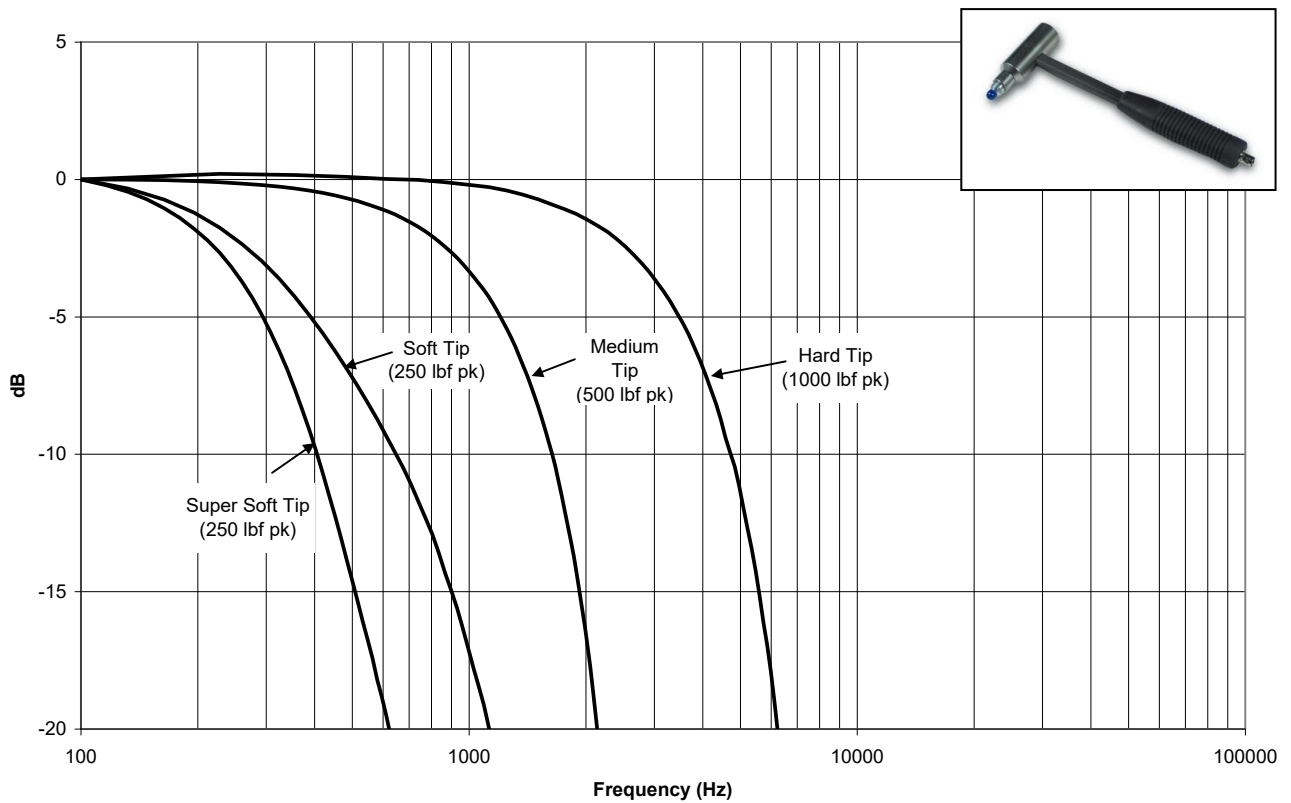

086D20, C41 Family Impulse Hammer Response Curves

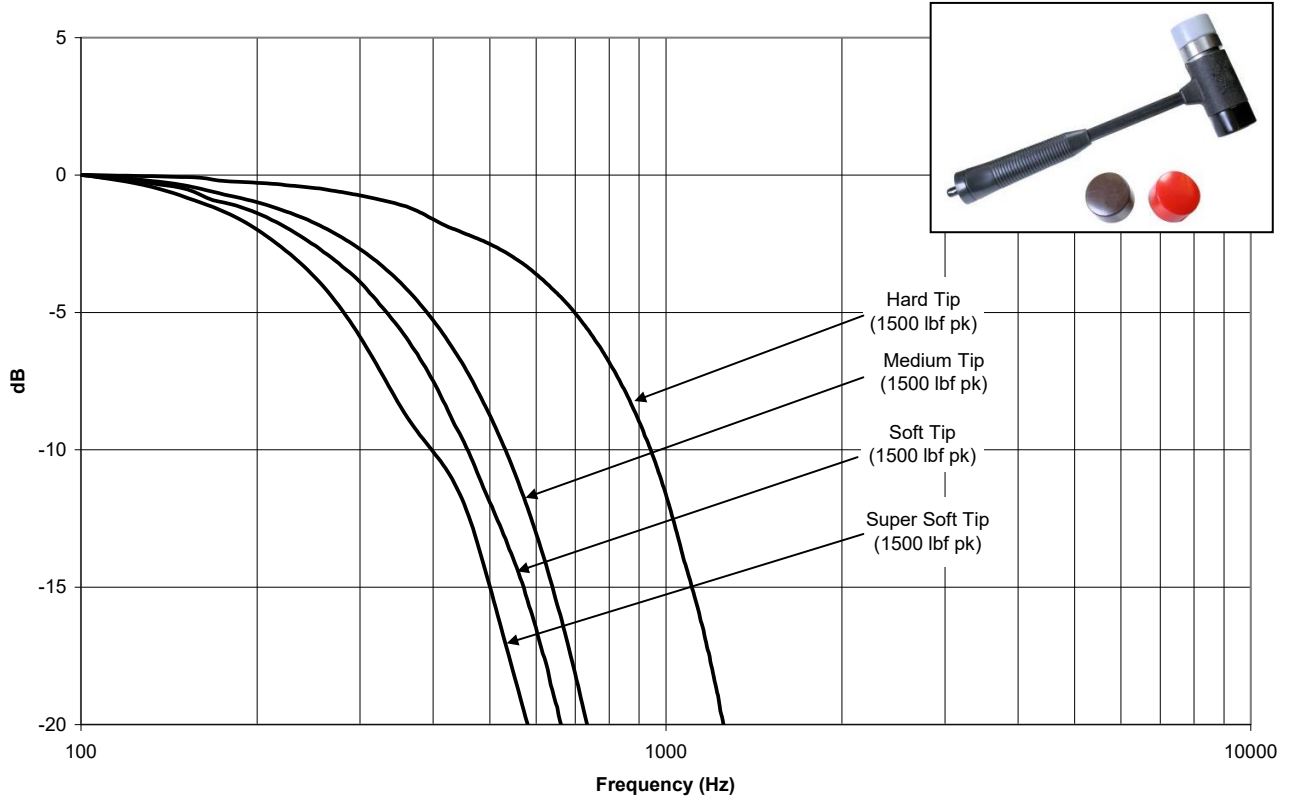

086D50, C42 Family Impulse Hammer Response Curves

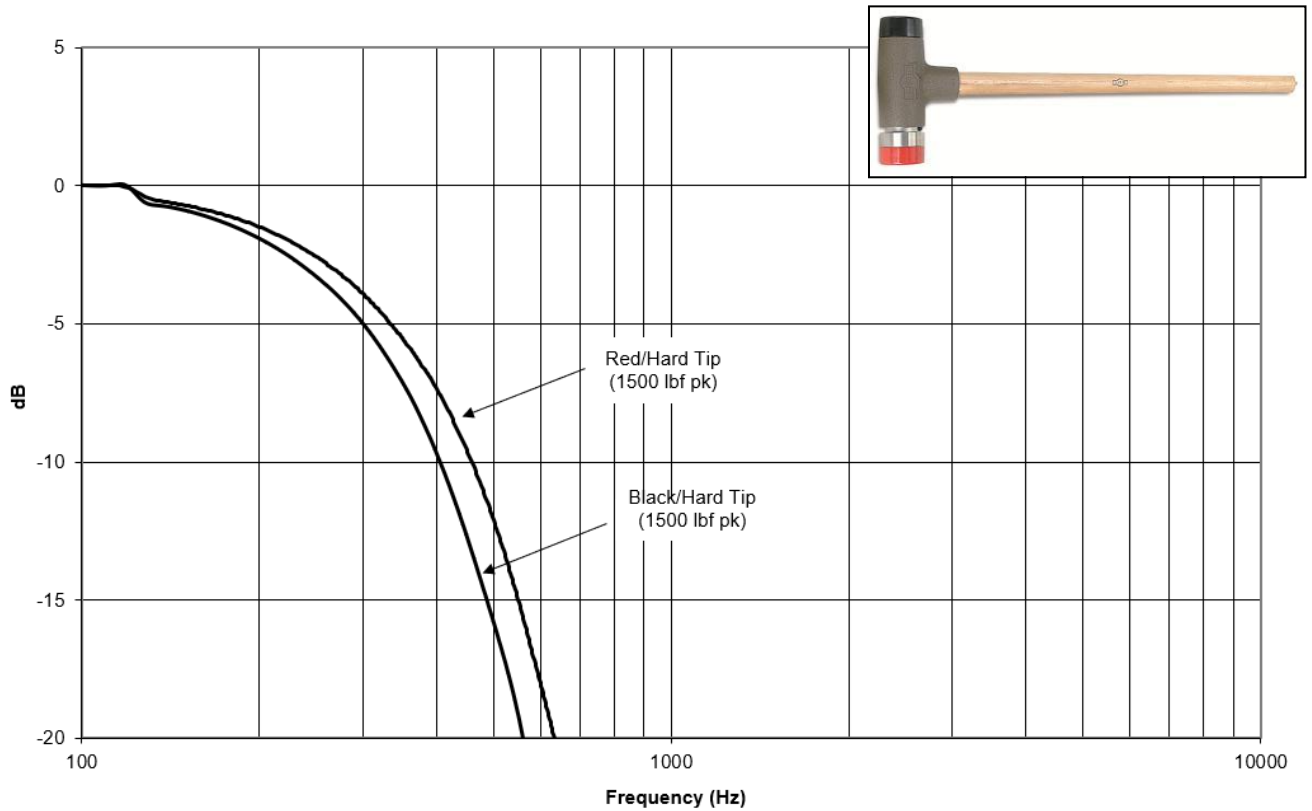

Hammer model selection involves determining the size and mass of the hammer structure which will provide the force amplitude and frequency content required for proper excitation of the structure under test. Large, heavy structures like locomotive frames, tanks and bridges require an instrumented sledgehammer; small structures like compressor blades often require mini-hammers. Some very large structures may require a massive mechanical ram instrumented with a force-sensing impact head.

2.0 DESCRIPTION

These hammer consists of an integral, ICP[®] quartz force sensor mounted on the striking end of the hammer head. The sensing element functions to transfer impact force into electrical signal for display and analysis. It is structured with rigid quartz crystals and a built-in, micro-electronic, unity gain amplifier. The cable is connected to the end of the handle for convenience, and to avoid connector damage in the event of a “miss hit.”

The ICP[®] sensor operates over a standard two-wire cable from a PCB[®] power unit. For reasons of safety, the easily-repairable ribbon wire cable is intended to be the weak link in larger hammer design. The ICP[®] signal conditioner supplies constant current excitation to the sensor over the signal lead and AC couples the output signal. Many FFT analyzers and data acquisition systems have ICP[®] power supply built in.

The hammer is a single, integral unit. Laser-welded construction of the sensor element insures reliable operation in adverse environments. The mechanical assembly is locked together with a structural epoxy adhesive, so it should not be taken apart except at the factory.

The striking end of the hammer has a threaded hole for installation of a variety of impact tips. The tip functions to transfer the force of impact to the sensor and protects the sensor face from damage. Tips of different stiffness allow you to vary the pulse width and frequency content of the force. The specific frequency range can be found in the datasheet supplied with hammer. An extender mass, supplied with most hammers, allows further tuning by concentrating more energy at lower frequencies.

3.0 INSTALLATION AND OPERATION

The hammer is assembled and locked together with structural adhesive at the factory. The tips and extender mass install at opposite ends of the hammer via 10-32 threaded studs. In the case of the model 086E80 mini impulse hammer, the handle is removable.

1. With the applicable cables, connect the hammer to an ICP[®] signal conditioner, and then connect that to your analyzer, as shown in the applicable signal conditioners' manual.
2. Tighten the cable connectors securely by hand to insure a good electrical contact.
3. Switch the power on, and wait a minute or two for the sensor amplifier to turn on and for the coupling capacitor to fully charge. Check the power unit's meter for normal operation (e.g. meter pointer pointing in green area).
4. If a meter's pointer points in the red area, look for shorted cables or connections. If a meter's pointer points in the yellow area, look for open cables or connections.
5. Connect the accelerometer(s) in a similar manner; referring to the appropriate operating guides for the accelerometer(s) and power unit. When all power unit meters indicate normal operation (green), proceed with the tests following all sensor, power unit and analyzer operating instructions.

4.0 TESTING

Generally speaking, the impact tips affect the hammer impulse frequency content, and the extender affects the signal energy level. Frequency content and energy level are interrelated, so both will be affected by different hammer structures. Hammer velocity at impact will also affect both. In general, massive structures with lower stiffness require the use of the extender and soft impact tip to adequately excite low frequency resonances.

The frequency range of the hammer can be varied by changing the type of tip used. The following guidelines can be used to determine the ideal hammer configuration for a particular test setup:

1. For a higher frequency response, use a stiffer tip without the extender mass.
2. For a lower frequency response, use a softer tip and install the extender mass.
3. To increase motion signal energy, increase the impact velocity and/or hammer mass.

When using the model 086E80 mini impact hammer, the model 084A17 handle is designed for use in frequency ranges lower than those reached when using the model 084A14 handle. When using the model 084A17 handle, best results are achieved by mounting the model 084A13 extender mass to the back of the hammer as shown on the outline drawing. This will improve the low frequency content of the force input to the structure, as well as improve the “feel” of the hammer by offsetting any effective mass added to the handle base by an attached cable.

To test the behavior of your structure and to tailor the frequency bandwidth of the force, follow the following procedure:

1. Strike the test object with the hammer and process the results. Always take several averages to reduce the effects of spurious noise.

CAUTION: *Never impact without a hammer tip properly installed on the sensor element. In the case of the model 086E80 mini impact hammer, the sensor element is pre-installed with a steel tip.*

2. Check the measured results for signal quality (adequate signal-to-noise), no overloads (overload lights or sharp flattening of time history peaks) and no double impacts.
3. Analyze results for frequency content, and check to ensure that the reasonably flat portion of the force spectrum is sufficient to cover the structural resonances present in the acceleration spectrum. Often signal energy is sufficient to excite structural resonances at 20 dB below initial low frequency force levels.

During testing, occasionally check and tighten the electrical and mechanical connections. Repeated impacting tends to loosen them, which may result in erratic and noisy signals.

Although modal tuning has done much to eliminate this possibility, bouncing (multiple impacts) or penetration may still occur when using too heavy a hammer on too light a structure or section of a structure. This will appear as an oscillatory component superimposed on the spectrum in your data. Reject such data. Some skill and practice may still be required when testing lighter structures.

PCB's ICP[®] power units providing greater than 10 volts positive signal range (three x 9 volt batteries) prevent undetected overloads in the power unit. Distortion, undershoot and oscillation of the impulse time history, as viewed on the analyzer display, is caused by ringing of the analyzer's anti-aliasing

filters, which is their normal behavior. To view the correct impulse waveform, switch the analyzer to a high-frequency range.

When configuring your oscilloscope or data acquisition system, it is recommended that the input be set to DC coupled. This is because, in some cases, the time constant associated with the equipment's AC coupling circuit is less than that of the impulse hammer and PCB ICP[®] power units. This will cause a small offset in the output voltage of the hammer after impact, which will appear as a negative dip in the response on the down slope of the response with a gradual rise back to zero over a period of time.

5.0 CALIBRATION

Calibration involves testing the functional transfer behavior (sensitivity) of the sensor structure in controlled transactions and environments.

Different hammer structures have different sensitivities. This is because the test structure experiences a force greater than the crystal-sensing elements. The force of impact on the test structure is a function of the total mass of the hammer, while the force on the crystals is a function of only the mass behind them (the impact tip is in front of the crystal-sensing element). Their differences, which depend on the ratio of the tip mass to the head mass, is automatically compensated for when the hammer is properly calibrated, since the extender mass is behind the sensing element. When used, it results in a slight increase in voltage sensitivity (as shown on calibration certificate). Each hammer structure can be easily calibrated to ensure the most accurate data.

A hammer can be calibrated by hitting a freely-suspended mass instrumented with a reference accelerometer. According to Newton's second law of motion, at any instant in time, the force experienced by the mass is simply the mass multiplied by the measured acceleration. On a storage oscilloscope, dividing the peak output signal of the hammer (mV) by the mass (lb or kg), times the peak acceleration (g), gives the hammer sensitivity directly in mV/lb or mV/kg.

Calibration on a FFT analyzer produces the same result as a function of frequency. Since the transfer function of a mass behaving as a rigid body is a consistent (1/M) ratio, the force and the acceleration signals produces a calibration constant (ideally 1/M) for each discrete frequency. The effects of a non-modally tuned hammer will be readily apparent when performing this calibration.

The mass, pendulously suspended or placed on a piece of foam rubber, will behave as a rigid body. Hitting such an instrumented mass is also a good way of checking the normal operation of the hammer and instruments prior to testing. This procedure builds confidence in data results.

6.0 MAINTENANCE

The sealed construction of the sensing element and the bonded construction of the hammer preclude field maintenance. Should service be required, first replace the cables (cables are often the source of trouble) and test operation again. If necessary, return the unit to the factory with a note describing the problem.

7.0 PRECAUTIONS

Although hammers are very rugged in construction, damage can result from misuse. When observed, the following precautions can ensure long life and accurate data.

1. Do not attempt to dismantle sensor element from hammer structure. All service should be performed at the factory.
2. Never generate more than 5 times the rated impact force range with any hammer. Generally, observe the force rating for five volts output. Excessive impact force may destroy the built-in miniature electronics.
3. Never strike an object without an impact tip properly installed in front of the force-sensing element. Damaging the precision-lapped surface of the hammer sensor can affect its behavior.
4. During testing, periodically check and tighten tip, extender and cable connections to ensure continued proper operation. Machined flats in the tips and extender facilitate tightening and removal.
5. Do not apply voltage to unit without constant current protection.
6. Do not apply more than 20 mA of current.
7. Do not exceed 30 volts supply voltage.
8. Do not subject units to temperatures above 250°F (121°C).
9. Ground the analyzer to prevent Electromagnetic Interference (EMI) from fluorescent lights or other sources effecting the signal.

8.0 WARRANTY AND SERVICE

All equipment and repair services provided by PCB Piezotronics, Inc. are covered by a warranty against defective material and workmanship under a **Total Customer Satisfaction** policy. See the supplemental sheet, contained with this manual, for information on our service, repair and return policies, procedures and instructions. When unexpected problems arise, call our 24-Hour SensorLineSM to discuss your immediate dynamic instrumentation needs with a factory representative. PCB guarantees **Total Customer Satisfaction**. If, at any time, for any reason, you are not completely satisfied with any PCB product, PCB will repair, replace, or exchange it at no charge. You may also choose to have your purchase price refunded. Contact PCB for a complete statement of our warranty.

3425 Walden Avenue, Depew, NY 14043-2495
E-Mail: info@pcb.com
Website: www.pcb.com

24-hour SensorLineSM: 716-684-0001
Fax: 716-684-0987
Toll-free (in the US): 800-828-8840

A PCB GROUP COMPANY

ISO 9001 CERTIFIED

A2LA ACCREDITED to ISO 17025

© 2024 PCB Group, Inc. In the interest of constant product improvement, specifications are subject to change without notice. PCB and ICP are registered trademarks of PCB Group, Inc. SensorLine is a service mark of PCB Group, Inc. All other trademarks are properties of the respective owners.

Manual Number: 19198
Manual Revision: B
ECO 54793











VIB-086 Manual – 04/24
Printed in the U.S.A.

PCB PIEZOTRONICS INC. **VIBRATION DIVISION**

TLD086 Series Modally Tuned[®] Impulse Hammers *TEDS Program Information*

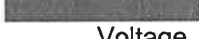
The hammer you have purchased has been programmed per IEEE 1451 version 1.0. This standard does not currently contain a specific template designed for Modally Tuned[®] Impulse Hammers. Instead your sensor has been programmed using only the relevant information from the standard Force Sensor template. Due to programming restrictions, all fields in a template must contain values. The table below indicates the fields that contain programmed values that are not relevant to your sensor (gray boxes.)

Template 25 Force Side

Manufacturer ID	23	
Model Number	86	
Version Letter	C	
Version Number	3	
Serial Number	12345	
Sens @ Reference Condition	0.1	V/N
High Pass cut-off Frequency		HZ
Stiffness of Transducer		N/m
Mass Below Gage		g
Sensitivity Direction (x, y, z)		
Transducer Weight		g
Transducer Electrical Signal Type	Voltage Sensor	
Mapping Method		
AC or DC Coupling		
Polarity		
Reference Frequency		Hz
Reference Temperature	22	C
Calibration Date	5/22/2007	
Calibration Initials	CAD	
Calibration Period	365	
Measurement Location ID	0	

3425 Walden Avenue, Depew, NY 14043-2495

E-Mail: vibration@pcb.com

Website: www.pcb.com

24-hour SensorLineSM: 716-684-0001

Fax: 716-6853886

Vibration Division toll-free: 888-684-0013

A PCB GROUP COMPANY

ISO 9001 CERTIFIED

A2LA ACCREDITED to ISO 17025

© 2007 PCB Group, Inc. In the interest of constant product improvement, specifications are subject to change without notice. PCB and ICP are registered trademarks of PCB Group, Inc. SensorLine is a service mark of PCB Group, Inc. All other trademarks are properties of the respective owners.

Manual Number: 37808
Manual Revision: NR

PCB PIEZOTRONICSSM
VIBRATION DIVISION

VIB-379 Manual – 06/07
Printed in the U.S.A.

Model Number

086C03

ICP® IMPACT HAMMER

Revision: L

ECN #: 32387

	ENGLISH	SI	
Performance			
Sensitivity(± 15 %)	10 mV/lbf	2.25 mV/N	
Measurement Range	± 500 lbf pk	± 2224 N pk	
Resonant Frequency	≥ 22 kHz	≥ 22 kHz	
Non-Linearity	≤ 1 %	≤ 1 %	
Electrical			
Excitation Voltage	20 to 30 VDC	20 to 30 VDC	
Constant Current Excitation	2 to 20 mA	2 to 20 mA	
Output Impedance	<100 ohm	<100 ohm	[1]
Output Bias Voltage	8 to 14 VDC	8 to 14 VDC	
Discharge Time Constant	≥ 2000 sec	≥ 2000 sec	[1]
Physical			
Sensing Element	Quartz	Quartz	
Sealing	Epoxy	Epoxy	
Hammer Mass	0.34 lb	0.16 kg	
Head Diameter	0.62 in	1.57 cm	
Tip Diameter	0.25 in	0.63 cm	
Hammer Length	8.5 in	21.6 cm	
Electrical Connection Position	Bottom of Handle	Bottom of Handle	
Extender Mass Weight	2.6 oz	75 gm	
Electrical Connector	BNC Jack	BNC Jack	

OPTIONAL VERSIONS

Optional versions have identical specifications and accessories as listed for the standard model except where noted below. More than one option may be used.

T - TEDS Capable of Digital Memory and Communication Compliant with IEEE P1451.4

TLD - TEDS Capable of Digital Memory and Communication Compliant with IEEE 1451.4

NOTES:

[1] Typical.

[2] See PCB Declaration of Conformance PS068 for details.

SUPPLIED ACCESSORIES:

Model 081B05 Mounting Stud (10-32 to 10-32) (2)

Model 084A08 Extender - Steel, 0.6" Diameter (1)

Model 084B03 Hard Tip- Hard (S.S) (1)

Model 084B04 Hammer Tip- Medium (White Plastic) (1)

Model 084C05 Hammer Tip- Soft (Black) (2)

Model 084C11 Hammer Tip- Supersoft (Red) (2)

Model 085A10 Vinyl Cover For Medium Tip (Blue) (2)

Model HCS-2 Calibration of Series 086 instrumented impact hammers (1)



[2]

All specifications are at room temperature unless otherwise specified.

In the interest of constant product improvement, we reserve the right to change specifications without notice.

ICP® is a registered trademark of PCB Group, Inc.

Entered: <i>JH</i>	Engineer: <i>Sgs</i>	Sales: <i>gpm</i>	Approved: <i>EB</i>	Spec Number:
Date: <i>2/24/10</i>	Date: <i>12/8/09</i>	Date: <i>2/17/10</i>	Date: <i>2/17/10</i>	15273

PCB PIEZOTRONICS™
VIBRATION DIVISION

3425 Walden Avenue, Depew, NY 14043

Phone: 716-684-0001

Fax: 716-685-3886

E-Mail: vibration@pcb.com

086-3020-95

PCB Piezotronics Inc. claims proprietary rights in the information disclosed herein. Neither it nor any reproduction thereof will be disclosed to others without written consent of PCB Piezotronics Inc.

REVISIONS

REV	DESCRIPTION	ECN	DATE	APP'D
E	REVISED PER ECN	22370	6/22/05	DM
F	UPDATED NOTES	25626	4/6/07	FB 4/6/07

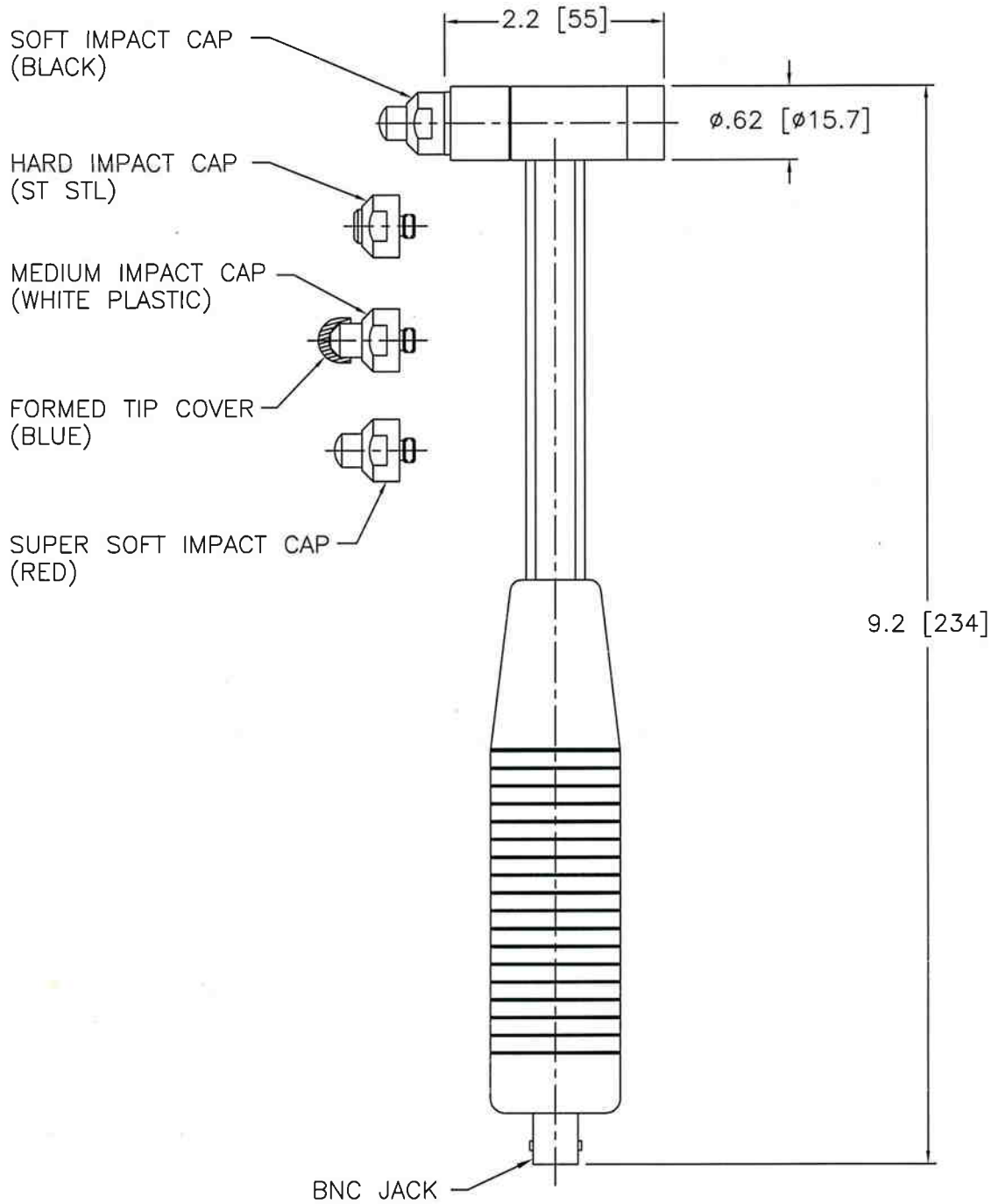

UNLESS SPECIFIED TOLERANCES		DRAWN				MFG		PCB PIEZOTRONICS™	
DIMENSIONS IN INCHES	DIMENSIONS IN MILLIMETERS [IN BRACKETS]	8255	4/10/07	4/23/07	MY	4/23/07	3425 WALDEN AVE. DEPEW, NY 14043	(716) 684-0001 EMAIL: SALES@PCB.COM CODE IDENT. NO. 086-3020-95 DWG. NO. 52681	
DECIMALS XX ±.03	DECIMALS X ±0.8	CHK'D	ECB	4/23/07	ENGR	CCR	716		
XXX ±.010	XX ±0.25	APP'D	FB	4/23/07	SALES	CSA	1/23/07	SCALE: .75x SHEET 1 OF 1	
ANGLES ±2 DEGREES	ANGLES ±2 DEGREES	TITLE				OUTLINE DRAWING			
FILLETS AND RADII .003 - .005	FILLETS AND RADII [0.07 - 0.13]					MODALLY TUNED			
DD011 REV. C 01/21/03						IMPULSE HAMMER			