



BEST USE INSTRUCTIONS

DEAR CUSTOMER,

Thank you for trusting PCB Piezotronics as part of your measurement solution. PCB sensors use a variety of technologies to provide accurate measurements for a wide range of applications. It's important to understand the specific strengths and weaknesses of your sensor's technology for safe handling and operation. The following guidelines are intended to help you get the most out of your new product while avoiding damage due to misuse. Please contact your local representative with any additional questions pertaining to sensor operation.



TOTAL CUSTOMER SATISFACTION, GUARANTEED

PCB's commitment to total customer satisfaction (TCS) empowers any employee to use all available means to exceed your expectations. If you are not completely satisfied with the performance or quality of our products or services, please let us know. Your feedback allows us to correct the situation & is of great importance to us as an organization.

CONTENTS

- I. ORDER RECEIPT** _____ **4**
 - Opening the Shipment Box _____ 4
 - Checking the Sensor Box _____ 4

- II. OUR TECHNOLOGIES** _____ **5**
 - Piezoelectric _____ 5
 - ICP® or Integrated Electronic Piezoelectric (IEPE) _____ 5
 - Piezoresistive (PR) _____ 5
 - Variable Capacitance (VC) _____ 5

- III. COMMON WEAKNESSES** _____ **5**

- IV. HANDLING CONSIDERATIONS** _____ **6**
 - Ovrange and Resonance _____ 6
 - ESD _____ 6
 - Cable Routing _____ 7
 - Other Precautions _____ 7

- V. BASIC SENSOR FUNCTIONALITY CHECKS** _____ **8**
 - Piezoelectric (PE) _____ 8
 - ICP® or Integrated Electronic Piezoelectric (IEPE) _____ 8
 - Piezoresistive (PR) _____ 9
 - Variable Capacitance (VC) _____ 10

- VI. ADDITIONAL HANDLING PRECAUTIONS** _____ **12**
 - Pressure Sensors _____ 12
 - Accelerometers _____ 13
 - Microphones _____ 14

- VII. AFTER SALES SERVICE** _____ **14**

I. ORDER RECEIPT

OPENING THE SHIPMENT BOX

Our products are protected inside your shipment package and secured in their own separate boxes. However, if your shipment arrives with traces of damage, please take pictures and report this immediately to your local PCB representative.

Check for all documents (calibration certificate, manual, and technical sheet) and accessories before removing your product.

CHECKING THE SENSOR BOX

Make sure that the sensor does not show external signs of damage that could be the result of improper transportation.

Your device is accurate and sensitive; misuse, mishandling, or improper storage could reduce its effectiveness.

Even without power, a sensor or its assembly can receive mechanical overstrain and be damaged. Do not simulate strain as pressure, shock or vibration by pressing, pulling or shaking the sensor.

Always use the appropriate equipment before handling a sensor. MEMS sensitive elements can be damaged by electrostatic discharge (ESD). ESD damages can occur even if the sensor is not powered.

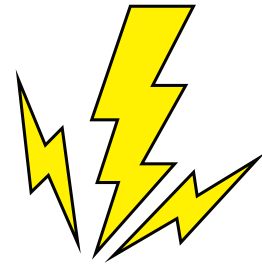

WARRANTY DOES NOT COVER MISHANDLING

II. OUR TECHNOLOGIES

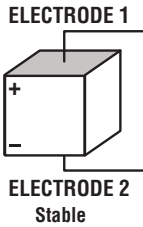

PIEZOELECTRIC

The sensing element is made from piezoelectric material. A stress (compression or shear) generated between two electrode sides of a crystal deliver charges in proportion to input.

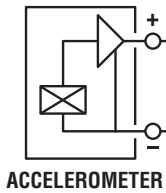

ICP® OR INTEGRATED ELECTRONIC PIEZOELECTRIC (IEPE)

IEPE sensors (also named ICP® and Isotron®) are a subfamily of piezoelectric devices, which include a built-in electrical circuit. These sensors integrate amplification, filter and PE signal conversion from the piezoelectric output to voltage or current output.

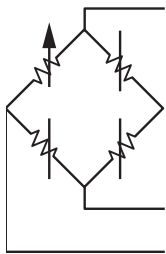

PIEZORESISTIVE (PR)

Wheatstone bridge sensors use resistive arms, whose values change under mechanical strain (from bending or shear). The bridge becomes unbalanced under stress and provides a ratiometric voltage output.

Standard PR devices do not integrate a conditioning circuit.

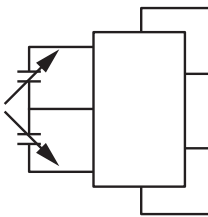

VARIABLE CAPACITANCE (VC)

One of the surfaces of a built-in capacitor circuit is maintained by arms. The strain under stress changes the distance between the surfaces. The unit delivers a voltage output.

III. COMMON WEAKNESSES

When sensing elements are subjected to mechanical strain, the potential for overrange, resonant frequency, and mechanical damages is introduced. Mechanical stops increase survivability, but do not prevent all damage risk from mishandling and misuse.

PCB's sensor outputs mostly use voltage interfaces. Various components help to protect the sensitive element and circuit against ESD, over-power or inversion of polarity; it is still recommended to take extra care with wiring and connections.

IV. HANDLING CONSIDERATIONS

OVERRANGE AND RESONANCE

Sensitive element technology is based on strain, which involves elastic, plastic and rupture domains for a 1st order dynamic system. To prevent overrange damage to your sensor, consider the following:

- a. Sensors may break if subjected to accelerations higher than their rated range. (Undamped units are especially vulnerable to this type of damage.)
- b. Sensors are especially susceptible to overrange damage while they are unmounted, due to potential resonance.
- c. Drops to the floor or taps against metal surfaces may not damage the sensor housing, but they cause extremely high frequencies, which can resonate and damage the sensing element.
- d. When unmounting the sensor from its install location:
 - i. For adhesive mount units, melt or dissolve epoxy as much as possible. Avoid “yanking” sensor off the surface.
 - ii. For screw-mount units, use the short end of the provided L-shaped Allen wrench.
- e. Use original sensor packaging (box, protective tube) as a safe storage and handling solution.

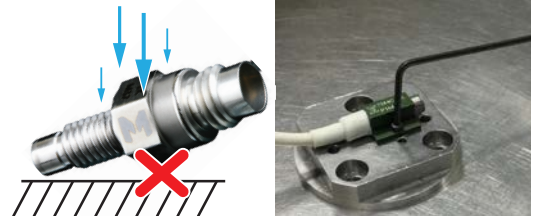
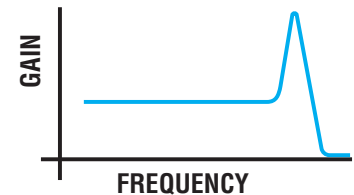
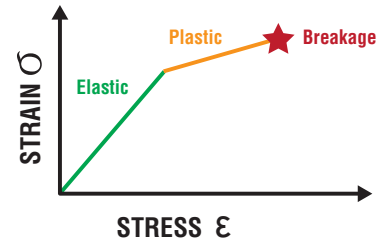

ESD

Electrostatic discharge is a known cause of major issues during operation. Sparks of energy may damage or destroy internal components of sub-miniature construction (e.g. MEMS).

- a. Highly ESD sensitive devices come in ESD bags with warning labels, but to be safe it is better to treat all sensors as ESD-sensitive devices
- b. Wear grounding straps and work at ESD-safe benches while handling sensors.
- c. Transport sensors in ESD-safe containers.
- d. Many sensors include ESD mitigation within the circuit, but should still be handled carefully.
- e. A transient voltage suppression (TVS) diode is built like a Zener diode. It is used specifically to nullify important voltage potentials and protect MEMS die from overvoltage.
- f. Many resistive devices, like crash testing sensors, include our TVS quad diode. Through tests involving multiple (dis)assemblies, this extra-safe design has been shown to increase sensor longevity.



CABLE ROUTING

During testing, the complete measurement system is exposed to the measured event (i.e., the shock, vibration, wave, etc.). There are many potential consequences if cables and connectors are not handled correctly; on the extreme end, breakage can occur, but mishandling could also result in noise or unexpected peaks.

- a. Give a few inches of a “strain relief loop” outside sensor housing. cable should never receive tension strain, be pinched, or have a forced angle.
- b. Secure cable to an unmoving surface or structure when possible. Less motion means less stress on the cable. Hitting the cable against a surface could generate signal.
- c. If a section of cable is subjected to shock or vibration, avoid coils or overlapping that section of cable over itself. Coiled sections tend to add extra unwanted noise compared to straight cable sections.
- d. Cable and coils are sensitive to magnetic fields, which generate induced current. On test and machine, a variable environment generating unstable EMC may create signal noise over the data. Straight lines of cable are less sensitive to EMC.

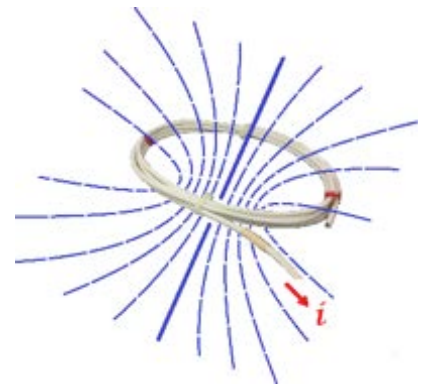
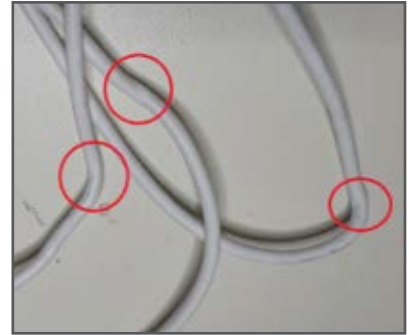

OTHER PRECAUTIONS

Each sensor is made to operate within a specific environment. Incorrect thermal, mechanical and/or electrical conditions may affect signal output or damage the sensor.

- a. Only use proper excitation voltage levels. High excitation voltage can overheat and damage the sensor.
- b. Keep the sensor within the temperature range specified on the datasheet. Excessive temperature (cold or hot) could prematurely age or break the components and assemblies.
- c. Insulation of connectors and solders protects the circuit from electrical arcs, leakage and short-circuit. Use the right insulator on wire leads to prevent contact with each other and/or the ground. Reduce, at minimum, contact with unshielded or unprotected areas.
- d. If the sensor gives suspicious readings, carefully try testing different parameters, like its isolation with the bench, its measurand output, and its signal response.



V. HANDLING CONSIDERATIONS

Each sensor technology used has its specific analogue circuit. By following a list of tests, users can check basic functionalities and characteristics. In order to review full sensor compliance against specifications, accredited metrological calibration often requires a traceable bench (e.g., pressure, vibration, or impact).

PIEZOELECTRIC (PE)

Due to their construction, PE sensors cannot easily be electrically controlled. A PE sensing element delivers a charge (in picocoulomb) when stressed.

- a. Potential checks for PE sensors:
 - Capacitance can be checked using a capacitance meter.
 - Resistance can be checked with an ohmmeter.

Values should be within range of those on device's calibration sheet and datasheet.

- b. Signal checks for PE sensors:

The signal cannot be directly measured with a multi-meter, as this technology requires specific electronic or conditioning devices. We suggest using a remote charge converter (RCC) or dedicated conditioners (single-ended or differential).

- For coaxial interface and single-ended sensors, use an RCC like 2771C.
- For differential output, use an inline electronic like 2777A.

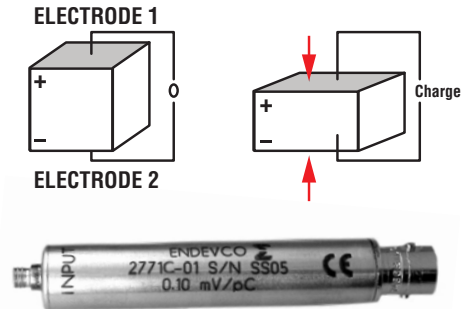

- SINGLE-ENDED**
- One central conductor
 - Cable braid is used in measurement

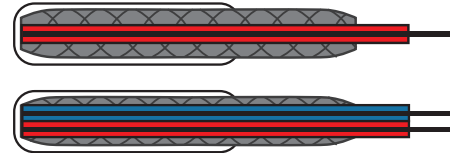

- DIFFERENTIAL**
- Two isolated conductors
 - Cable braid is used as shield only

ICP® OR INTEGRATED ELECTRONIC PIEZOELECTRIC (IEPE)

IEPE sensors are 2-wire piezoelectric sensors. Power is supplied with a constant current and a compliance voltage (typically 18 to 30 Vdc). Signal is measured in volt around an offset (also referred to as “bias”) which is around 50% of the compliance voltage.

It is recommended to use industrial IEPE conditioning equipment (e.g. 4416C or 480C02) to check devices, as the electrical schematic is uncommon.

For 3-axis sensors, each channel needs independent power instead of a common power line.

- a. Potential checks for IEPE sensors:
 - Resistance can be verified with an ohmmeter.
 - Bias voltage can be measured using a T connector and a voltmeter as a hub in signal chain.
 - Sensitivity can be checked with a known and alternative input, as IEPE devices do not reply correctly to constant strain (e.g. shakers are recommended for vibration sensors, and pistonphones for microphones).
 - Values should be within range of those on device's calibration sheet and datasheet.
- b. Signal checks for IEPE sensors:
 - Dynamic excitation (no impact) should generate signal that a voltmeter (thru T connector) or IEPE conditioning equipment will detect.

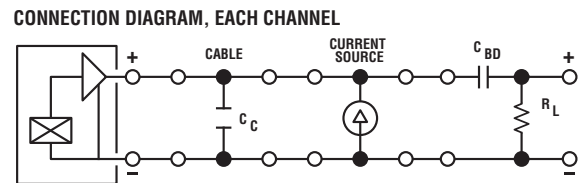

PIEZORESISTIVE (PR)

Most PR unamplified sensors (pressure and accelerometers) are manufactured as full-bridge circuit with two or four active arms. They do not integrate conditioning electronics, and deliver a signal proportional to strain and excitation

PR sensors may present different parameters to check:

1. Insulation: Defective insulation could generate current leak or short-circuit.
2. ZMO: Significant offset on bridge could be a sign of mechanical damage (e.g. overrange or ESD) on sensing element.
3. Signal stability with regulated supply: Excessive noise on output could come from defective element, bad contact, wet solder, or cable micro cut.
4. Incorrect sensitivity in standard condition occurs when bridge or its mechanical interface is damaged.
 - a. Potential checks for PR sensors:
 - Insulation: Check all wires to braid and housing with a mega-ohmmeter
 - Resistance: Verify ZIN and ZOUT with an ohmmeter
 - Values should be within range of those on device's calibration sheet and datasheet.
 - b. Signal checks for PR sensors:
 - Any PR sensor can measure permanent or DC (0 Hz) strain.
 - It is important that the following values remain within tolerances; conditions may differ slightly from factory's calibration laboratory.
 - c. For PR pressure sensors:
 - Check atmospheric pressure (or 15 psia).
 - Depending on sensor range, the sensor could react to air blow.

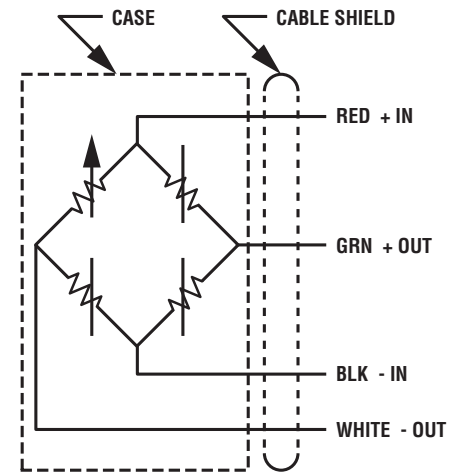

Never touch a pressure diaphragm with fingers!

- d. For PR sensors that measure vibration/shock:
 - Measure ZMO by putting the device in transverse position.
 - Depending on its range, a +/- 1g flip is possible to check its value and symmetry.

It is not recommended to hit the sensor directly, as this could damage the sensitive element (chapter I.A).

- e. For PR load cells:
 - To check ZMO and sensitivity, static force could be applied with weights, depending on sensor range.

COMMON ELECTRICAL FAILURE CAUSES:

1. Power supply is too high: PR sensors are made to be powered from 2 to 10Vdc (max 12Vdc) or even less, if specified in datasheet and calibration sheet. Overvoltage (e.g. 24Vdc) will overheat the gages and cause damage (up to breaking the sensor).
2. Wrong wiring: power supply is made between +IN and -IN. Powering incorrect wiring (e.g. between +IN and +OUT) will overheat one arm/gage of the bridge and cause damage (up to breaking the gage).

Both above errors can lead to instant destruction of the sensor!

VARIABLE CAPACITANCE (VC)

VC sensors are always supplied with internal electronics (conditioning and amplification). These electronics are designed to be secure against polarity inversion on EXC and GND, but circuitry is not protected against incorrect wiring.

VC sensors exhibit either single-ended or differential outputs.

Any sensor can be used as a single-ended output; the device requires three wires to be functional: GND, EXC and +OUT. In most of cases, they will deliver signal 0.5 to 4.5V, centered at 2.5V as ZMO.

One extra wire -OUT (e.g. 2.5V potential) is often available to provide a differential output $\pm 2V$, centered at 0V as ZMO.

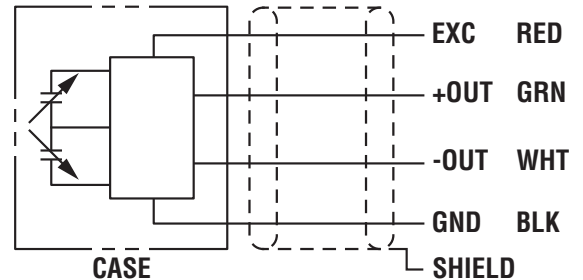

RED +EXC

GREEN +OUT

WHITE -OUT (not used)

BLACK -EXC

BIAS 2,5Vdc
Output $\pm 2Vdc$



RED +EXC

GREEN +OUT

WHITE -OUT

BLACK -EXC

BIAS 0Vdc
Output $\pm 2Vdc$



If all GND used for power supply could be connected, it is not recommended to connect all -OUT together. Their slight voltage differences as reference (V_{-OUT1} , V_{-OUT2} , etc.) may differ and cause issues with signal quality.

For single-ended output, GND wire can be duplicated to split power and signal lines. It will remain a single-ended output.

a. Potential checks for VC sensors

- Insulation: Check all wires to braid and/or housing with a mega-ohmmeter.
- –OUT reference voltage: Use a voltmeter between GND and -OUT

b. Signal checks for VC sensors

- Any VC sensor can measure permanent or DC (0 Hz) strain. Check conditions should not affect tolerances and values, which should stay very close to the factory's.

c. For VC sensors that measure vibration/shock:

- ZMO: Put the device in transverse position.
- Sensitivity: Depending on its range, a $\pm 1g$ flip is possible to check functionality and symmetry.

d. For angular rate sensors:

- ZMO: Measured in static state.
- Signal: Applying a motion will change it, but verification of other properties require a calibration bench.

e. Microphones:

- ZMO: Could be checked in an isolated box.
- A handclap could help determine if the sensor reacts to excitation; a pistonphone would provide a calibrated point as reference.

For single ended output, GND wire can be duplicated to split power and signal lines. It remains a single ended output.

COMMON ELECTRICAL FAILURE CAUSES:

1. Wrong wiring: Incorrect wiring may damage the circuit. If EXC is connected to any other wire (except GND), it can instantly damage circuit (operational amplifier or –OUT reference).

2. Power consumption: Depending on sensor, for triaxial devices, GND and EXC lines might be common. If each axis has its own –OUT, they should never be connected.

VI. ADDITIONAL HANDLING PRECAUTIONS

PRESSURE SENSORS

PE and IEPE Pressure Sensors

PCB Piezotronics' PE and IEPE pressure sensors use built-in stainless steel housing, which makes them extremely robust for use and handling. Care should still be taken to avoid drops and mechanical shocks to these sensors.

PR Pressure Sensors

PR pressure sensors can be damaged by touching the diaphragm. Even if the sensitive element is protected behind a screen, avoid any simulation of pressure by touch (e.g. with fingers), and make sure that no hard particles (e.g. particles in the media) come in contact with the membrane.

The pressure cavity is designed to be compatible with dry, clean gases.

PR pressure sensors are not recommended for use in water or moisture-condensing environments. If you suspect that the pressure media has degraded the transducer, contact the factory for appropriate recommendations.

The media is exposed to the sensor's materials, such as CRES, epoxy, silicon, and parylene C; for more details, please read the technical paper TP338.



Mounting

1. Make sure that sensor housing material is similar to mounting material to avoid different thermal expansions. This will prevent strain or release due to temperature changes.
2. Apply the recommended tightening torque given in the data sheet or performance sheet. A low torque will affect sensor and signal behavior for dynamic pressure, and an over-torque can cause damage.

ACCELEROMETERS

Avoid direct hits on accelerometer housing.

PR and VC Accelerometers

PR and VC accelerometers are resistant to overload as they contain built-in mechanical stops.

Undamped or lightly damped construction allows for high frequency measurements. They should not be used for near-field shocks to prevent them from “ringing” at their nominal frequencies.

Critically damped or multi-mode damping devices are designed to minimize the effects of resonance.

PE and IEPE Accelerometers

PR pressure sensors can be damaged by touching the diaphragm. Even if the sensitive element is protected behind a screen, avoid any simulation of pressure by touch (e.g. with fingers), and make sure that no hard particles (e.g. particles in the media) come in contact with the membrane.

The pressure cavity is designed to be compatible with dry, clean gases. PR pressure sensors are not recommended for use in water or moisture-condensing environments. If you suspect that the pressure media has degraded the transducer, contact the factory for appropriate recommendations.

The media is exposed to the sensor’s materials, such as CRES, epoxy, silicon, and parylene C; for more details, please read the technical paper TP338.

Mounting

1. The mounting surface has to be as flat and even as possible to prevent base strain or system resonant frequency disturbance. (Uneven surfaces add unexpected sub-frequencies). A more detailed document is available in the Endevco technical paper TP319.
2. Cable has to be correctly maintained to prevent fatigue stress on cable and connectors. Secure the cable with tape between 2” to 6” from the sensor, leaving some slack in the cable to prevent any strain. Proper cabling prevents triboelectric effects and disturbance.
3. Apply the recommended tightening torque given in the data sheet or performance sheet. A low torque could affect system by adding unwanted resonance frequencies, and an over-torque can cause damage.
4. Always use grease for the sensor’s threaded assembly to ensure optimum vibration transmission from the structure to the sensor.

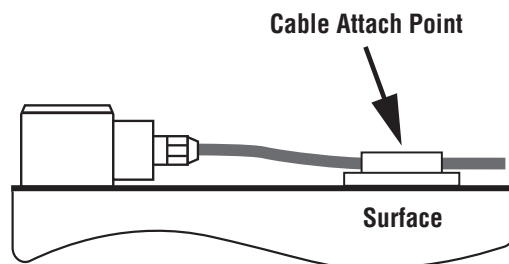
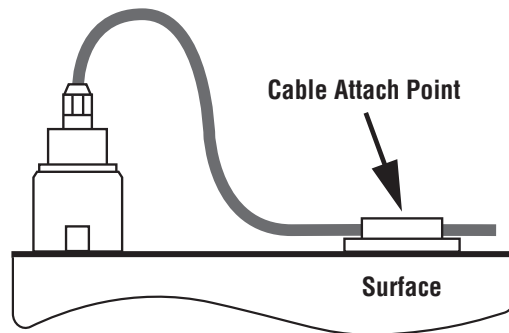

MICROPHONES

Most microphones are designed with a variable capacitive sensing element (electret) and a 2-wire conditioning circuit, compatible with ICP® systems' interfaces.

The membrane of these sensors is made with a very thin aluminum film (thickness 0.02mm); extra care is necessary for any operation.



Handling

Protection caps are supplied to protect the connector output only, they should never be mounted on sensing side; the overpressure generated while pushing the cap may cause damage.

A grid is mounted to protect the diaphragm; it should neither be removed nor hit a hard surface.

Microphones pick the reference to atmospheric pressure with an equalization hole. It must never be obstructed.



Cleaning

The microphone's fragile membrane must not be cleaned by contact with a tool; use a manual air dust bulb and orient it on the side to blow out dust without risking excessive frontal pressure.



VII. AFTER-SALES SERVICE

For any question regarding the use of our sensors and materials, please contact your local area sales manager or distributor by calling (toll-free in the US) 800-828-8840 or email sales@endevco.com or info@pcb.com.



3425 Walden Avenue, Depew, NY 14043 USA

pcb.com | info@pcb.com | 800 828 8840 | +1 716 684 0001

© 2022 PCB Piezotronics - all rights reserved. PCB Piezotronics is a wholly-owned subsidiary of Amphenol Corporation. Endevo is an assumed name of PCB Piezotronics of North Carolina, Inc., which is a wholly-owned subsidiary of PCB Piezotronics, Inc. Accumetrics, Inc. and The Modal Shop, Inc. are wholly-owned subsidiaries of PCB Piezotronics, Inc. IMI Sensors and Larson Davis are Divisions of PCB Piezotronics, Inc. Except for any third party marks for which attribution is provided herein, the company names and product names used in this document may be the registered trademarks or unregistered trademarks of PCB Piezotronics, Inc., PCB Piezotronics of North Carolina, Inc. (d/b/a Endevo), The Modal Shop, Inc. or Accumetrics, Inc. Detailed trademark ownership information is available at www.pcb.com/trademarkownership.

TM-HandlingInstructions-0623